

A young child with light hair, wearing a bright blue long-sleeved shirt and blue jeans, is climbing a rope structure on a playground. The child is holding onto a thick, dark rope with both hands. The structure is made of yellow plastic connectors and dark metal poles. The background shows a wooden wall and a clear blue sky with some clouds. The child's shirt has the text "DADDY AND I PLAY GAMES" printed on it.

glovis 

glovis  PLAY





glovis PLAY



**Tajna našeg  
uspjeha: vrhunska  
oprema za igru  
koja u potpunosti  
nadahnjuje!**





32

Woody classic



36

Woddy ecco



38

Robinia



42

Round woody



48

Steel classic



56

Steel plus



62

Steel big+



70

Swingoo



74

Spinngoo



75

Springoo



76

Climboo



79

Soloo



86

Topicoo



90

Rubber



94

Urban



102

Sport



# O NAMA

Dobrodošli na mjesto gdje možete naručiti kvalitetnu i sigurnu opremu za igralište!

Glovis doo je porodična kompanija osnovana 2011. godine, a do danas je izrasla u najmoderniji i najopremljeniji proizvodni pogon za proizvodnju igrališta u Bosni i Hercegovini, sa oko 25 zaposlenih koji brinu o razvoju, proizvodnji i prodaji visokokvalitetnih proizvoda širom BiH i regiona.

Osnovna djelatnost kompanije je **proizvodnja igrališta za javnu i privatnu upotrebu, proizvodnja urbanog mobilijara** (korpe za otpad, klupe, autobuska stajališta, niše za kontejnere, biciklistička stajališta...), **kao i vrhunskog sportskog mobilijara** (fitness oprema, opremu za sport, koševе, golove).

Svi naši proizvodi su od najkvalitetnijih vrsta drveta (sibirski ariš, bagrem, jela, smrča itd), metala, specijalnih HDPE masa, polipropilenskih užadi itd.

**Koristimo moderne i ekološki prihvatljive materijale u kombinaciji sa najboljim postupcima njihove zaštite:** metalni profili su od nehrđajućeg čelika ili se podvrgavaju postupku cinčanja ili praškastog farbanja, a drveni elementi su od najboljih vrsta drveta za određenu namjenu i po potrebi se podvrgavaju metodi zaštite dubinskom impregnacijom u komori pod visokim pritiskom. Izgradili smo visoko napredne, uzastopne operacije proizvodnje koje kada se ukombinuju sa fleksibilnom i pouzdanom montažom i ugradnjom dozvoljavaju nam da preuzmemo potpunu odgovornost ne samo za naše proizvode nego i za njihovu montažu i ugradnju.

Naši proizvodi su certificirani, dugotrajni, otporni na atmosferlije, koroziju i štetočine. Koristimo materijale neškodljive za okoliš, a većina materijala može se reciklirati.





# NAŠI BRENDovi

Kontinuiranim razvojem i ulaganjem brendirali smo četiri grupe proizvoda:

**glovis** PLAY

## DJEČIJA IGRALIŠTA ZA JAVNU UPOTREBU

Od javnih parkova do gradskih četvrti, od igraonica do školskih dvorišta: zahvaljujući našem velikom, asortimanu, sigurno ćemo pronaći savršeno rješenje za vaše zahtjeve. Možete se osloniti na nas i kada je u pitanju planiranje i implementacija tematskih jedinstvenih svjetova za igru mališana.



**glovis** FUN

## DJEČIJA IGRALIŠTA ZA PRIVATNU UPOTREBU

Kreirajte savršeno dvorište koje će odgovoriti na sve potrebe vaših mališana i cijele porodice. Volimo dizajniranje i izradu inovativnih vrtnih ljučki i setova kao i kućica za dječiju igru koje potiču dječji razvoj na ugodan način: drvene kućice za igru koje nadahnjuju kreativnost, moduli za penjanje koji potiču čvrstoću, viseći mostovi koji poboljšavaju ravnotežu, ljučke koje potiču motoričke i društvene vještine.



**do it**  
YOURSELF



**glovis** WOOD

## DUBINSKA IMPREGNACIJA DRVETA

Dubinskom impregnacijom pod visokim pritiskom se produžava životni vijek obrađenog drveta minimalno 3 do 5 puta. To štedi resurse, drvenu sirovinu, smanjuje troškove obnove, sanacije i (ponovne) proizvodnje, a ugljen dioksid koji se skladišti u drvu, ostaje u njemu duže vrijeme. Istovremeno, domaće autohtone vrste mogu trajati mnogo duže i ekonomičnije se koristiti.



**glovis** COLOR

## PLASTIFIKACIJA METALNIH PROIZVODA

Na savremen i ekološki prihvatljiv način radimo bojenje proizvoda od čelika, toplo ili hladno pocinčanog čelika, i raznih legura čelika. Možete birati među brojnim nijansama boja prema RAL kartama. Praškaste boje dostupne su u različitim strukturama, od glatkih, finih, grubih, mat ili sjajnih struktura, te različitih posebnih efekata kao što su efekat perle, metalik ili tzv. narandžina kora.





# Sigurnost dječijih igrališta je **NAJVAŽNIJA**

Glovis je prepoznat kao vodeći bosanskohercegovački proizvođač dječijih igrališta. Sva naša igrališta su dizajnirana na način da prije svega poštuju mjere za sigurnost djece na dječijim igralištima. Kada je u pitanju sigurnost, igrališta su testirana i certificirana od akreditovane laboratorije za ispitivanje prema standardu BAS EN 1176 (Evropski standard za sigurnost dječijih igrališta). Svi materijali su napravljeni prema najstrožim evropskim zdravstvenim i sigurnosnim zahtjevima, vodootporni su i UV rezistentni.



Naš cilj je da se spriječe i minimiziraju povrede djece na igralištima, a kako bi to postigli uveli smo upravo standard za sigurnost dječijih igrališta i sva oprema koju posjedujemo i involviramo u igrališta su prošla najstrožije kontrole kvaliteta, ne samo sa sigurnosnog nego i medicinskog aspekta.



# PO ČEMU SMO POSEBNI?

# 1

## Igra je važna!

Izumitelj vrtića Friedrich Froebel rekao je ovu značajnu rečenicu: „Igra nije igrarija. To je vrlo ozbiljna stvar i ima duboko značenje.“

Inspirisani ovim riječima, odlučni smo dati igri vrijednost koju zaslužuje! U našoj kompaniji, vrijednost igre je centralni kriterij naše filozofije. Zadovoljni samo ako su svi aspekti, svi zahtjevi naše opreme za igru ispunjeni u smislu stvarne vrijednosti.

Edukativni zahtjevi za opremom su naglo porasli u posljednjih nekoliko decenija, što je dobro. Naposljetku, riječ je o razvoju budućih generacija prilagođenom djeci, jer djeca uče kroz igru i pokret!

Smatramo da je jako važno sagledati cjelokupan koncept, te da stručnjaci za obrazovanje i razvoj djece budu uključeni u razvojni koncept igrališta. Zbog toga nam je uska suradnja s onima koji se svakodnevno bave našom opremom za igru toliko važna. Najljepše igralište nema svrhu i neće se koristiti ako se djeca ne želi igrati tu.



**Tako inspirisani samom vrijednošću igre, mi u našoj kompaniji promovisemo i unaprijeđujemo:**

- > Radost i uživanje u pokretu
- > Socijalne kompetencije
- > Kreativnost i maštu
- > Finu i grubu motoriku
- > Sva čula
- > Znanje i trodimenzionalno razmišljanje
- > Spremnost za eksperimentiranje
- > Istraživanje elemenata
- > Opuštenost i osjećaj reda
- > Osnove zajedničkog života



## Inovativnost

Funkcionalnost i dizajn – to je nenadmašna kombinacija koja garantuje entuzijazam! Uz dobro osmišljena igrališta, stvaramo maštovita i funkcionalna životna okruženja koja fasciniraju djecu i roditelje. Poseban naglasak pridaje se obrazovnom konceptu, a razvoj djeteta potiče se na razigran način zahvaljujući sofisticiranim konceptima.

Mi analiziramo trendove u pogledu njihove korisnosti i pretvaramo ih u korisne proizvode, edukativne, maštovite i apsolutno prilagođene djeci odnosno ciljnoj grupi.

Mi se bavimo problemima i zahtjevima društva, razrađujemo funkcionalna, tehnički sofisticirana rješenja i redovno pratimo najnovija dešavanja iz svijeta igrališta i opreme za djecu. U razvoju proizvoda oslanjamo se na optimalnu kombinaciju zabave, inovacija i funkcionalnosti.



2

## 3 Individualnost

Bilo da trebate opremu i igralište za dječji vrtić, trim sprave za aktivnosti mladih i starijih na javnim prostorima ili igrališta za otvorene ili zatvorene prostore - naš veliki asortiman nudi raznolikost dizajnerskih mogućnosti i sigurno ćete naći nešto što vam se dopada. Planiramo i proizvodimo svako igralište individualno prilagođeno vašem projektu, vašim zahtjevima i uslovima planirane lokacije - jer mi proizvodimo igrališta po mjeri!

Na svaki zahtjev imamo odgovor:

- > Grad: Igrališta za javne površine za velike i manje gradove.
- > Slobodno vrijeme i turizam: Dobro osmišljeni svjetovi igre za zoološke vrtove, restorane, hotele, kampove i muzeje.
- > Zajednica: Igrališta za otvorene javne površine, stanovanje, manje gradove i mjesne zajednice.
- > Škola: edukativni, pedagoški koncept za škole, vrtiće, jaslice.

## Okoliš

Održivost, zaštita životne sredine, ekološka ravnoteža - ovaj trio obećava buduću održivost!

Proizvodnja igrališta i urbanog mobilijara kod nas se odvija na što je moguće ekološki prihvatljiviji i održiviji način. Za svoje proizvode koristimo ekološki prihvatljive materijale i sirovine bez štetnih tvari.

Naša kompanija zna o vrijednosti sirovine posebno drveta i upoznati smo sa strogim kriterijima obrade. Prilikom dizajniranja igrališta prvenstveno pazimo da se koriste što prirodniji materijali, koji će svojim izgledom podsjećati na prirodu u svom izvornom obliku.



## 5

## Sigurnost

Otporan, izdržljiv, pouzdan, testiran – to su osobine naših proizvoda, a mi idealan partner kada je u pitanju sigurnost. Naši proizvodi su certificirani i na taj način zadovoljavaju sve potrebne EU standarde, to je izazov s kojim se rado suočavamo, stoga naša igrališta odlikuju osobine poput:

- > izuzetno elastične, stabilne i izdržljive konstrukcije
- > saradnja sa stručnjacima za ispitivanje dječijih igrališta
- > redovne procedure certificiranja i ispitivanja
- > dodatne sigurnosne kontrole
- > certificirano prema BAS EN 1176.





## Kvalitet

Što se tiče ideja kao i proizvodnje i planiranja: samo najbolje je dovoljno dobro. Pažljivo odabrane sirovine, najsavremenija tehnologija, visoki standardi, dobro promišljeni koncepti - tu se temelji naša korporativna filozofija. Napokon, želimo da se djeca ovoga svijeta mogu igrati u miru i sigurnosti. A to je moguće samo ako svi pružimo sve od sebe.

6



7

## Puna usluga

Nudimo profesionalnu svestranu uslugu, što se tiče dizajna novih igrališta, od početka projekta vam pružamo potpunu uslugu: individualni savjeti, posjete na licu mjesta i posebno razvijeni koncept za svakog klijenta pojedinačno! Provodimo vaše ideje u jasan, konkretan koncept i zajedno s vama utvrđujemo pojedinačne faze i troškove za realizaciju vašeg projekta. Naši projektni menadžeri rade zajedno s našim internim stručnjacima, tako da imate direktnu, odgovornu kontakt osobu koja ima pristup širokom specijaliziranom znanju kako biste dobili najbolji mogući rezultat.

Dakle, pružamo:

- > lično savjetovanje
- > razvoj kreativnog koncepta
- > stručno znanje
- > montaža prilagođena terenu
- > dugoročna garancija za proizvod
- > servis dijelova.



## 8

## Pouzdanost

Naš tim osigurava da su igrališta precizno prilagođena potrebama naših kupaca i precizno planirana do najsitnijih detalja. Tačnost nam je jednako važna kao i pažljivo sklapanje igrališta. Jer kada je u pitanju oprema za igranje i igrališta, mi smo vaš pouzdani partner.

Zašto nam možete 100% vjerovati:

- > partner za dugoročnu saradnju
- > čvrsti poslovni temelji
- > brzi i pouzdani odgovori na upite
- > otvorena komunikacija.



## 9

## Cjelovitost

Cjelokupan koncept za izvrsnu zabavu i užitak prilikom igre - razvijen i preporučen od strane pedagoga i vaspitača. Mi želimo da pružimo djeci samo najbolje: da otkrivaju nove stvari, igraju se i budu u potpunosti sretni.

Naša igrališta su dječiji životni prostor u kojem se podstiče razvoj djece u stimulativnom okruženju. Stoga smo u toku sa najnovijim saznanjima iz razvoja i istraživanja igara i dječijih igrališta. Naš cilj u tom smislu jeste maštoviti svijet igre najboljeg kvaliteta koji nadahnjuje djecu i pruža im edukativnu vrijednost. Da bismo to učinili, razmišljamo „izvan okvira“ i usko saradujemo s prosvjetnim radnicima, roditeljima i nastavnicima, laboratorijom za ispitivanje igrališta i namještaja. Mi želimo da se djeca što više igraju na otvorenom, jer se na taj način aktivira više senzornih kanala, trajnije se usvajaju nove informacije.



## Dostupnost

Naša kompanija sa sjedištem u Zenici jedan je od najmodernijih proizvodnih pogona za proizvodnju igrališta i urbanog mobiljara u našoj zemlji sa tendencijom širenja u sve zemlje regiona.

## 10



# OD IDEJE DO REALIZACIJE!

Visoka vrijednost igre vam je glavni prioritet, ali budžetska ograničenja otežavaju planiranje vašeg igrališta? Zato se pouzdajte u našu kompetentnost za planiranje: rado ćemo implementirati vaše igralište za vas i s vama!

## Planiranje

Da bi igralište ne samo izgledalo lijepo, već i da bi bilo funkcionalno, postoji nekoliko stvari koje treba uzeti u obzir prilikom planiranja igrališta. Zahvaljujući našem iskustvu, upoznati smo sa svim zahtjevima dizajna igrališta.

Kompetentnost u planiranju znači razmotriti svaki aspekt igrališta. Stoga na početku svakog procesa planiranja postoji analiza budućeg opsega prostora za dječije igralište te potreba kupca i korisnika. To je jedini način na koji planiranjem igrališta možemo postići najviši kvalitet i stvoriti igralište koje je održivo u smislu svoje društvene funkcije i funkcije promocije vježbanja i pokreta.

Slijed kretanja, zone za igru i sigurnosne zone naši profesionalci u odjelu za planiranje razmatraju i smisleno uređuju od samog početka. Izbor proizvoda u potpunosti ovisi o vašim željama i zahtjevima vaših posjetitelja ili korisnika. Kako biste mogli vidjeti kako bi vaše igralište moglo izgledati prije nego što bude implementirano, poslat ćemo vam realan i pregledan plan ili 3D vizualizaciju.

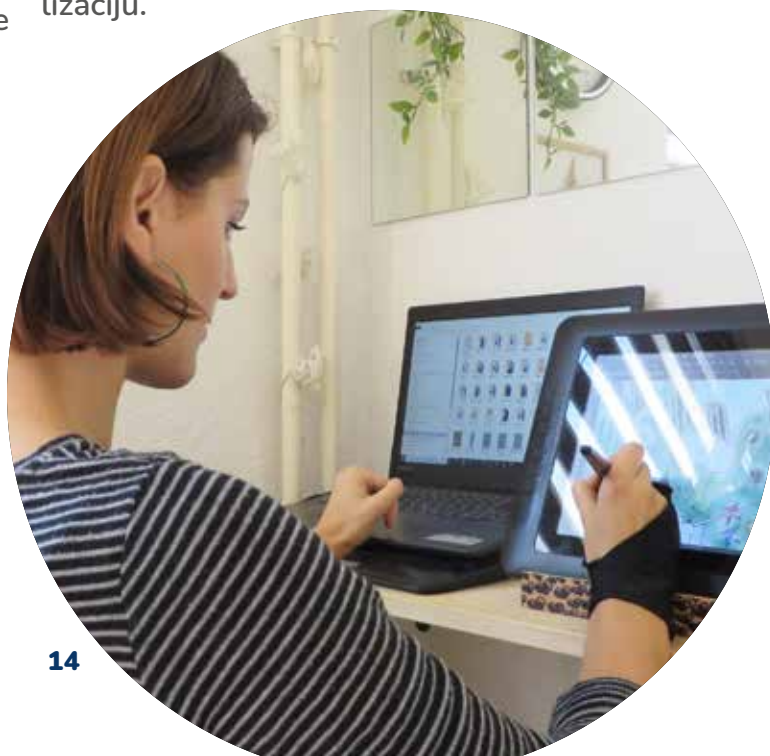

## Analiza područja za igru

Prvi korak u planiranju igrališta je analiza područja za igru. Naši stručnjaci uzimaju u obzir sve postojeće činjenice:

- > cjelokupno područje gdje će se nalaziti igralište, topografiju i prirodne karakteristike,
- > položaj u krajoliku tj. okolini, strane pristupa
- > karakteristike potencijalnih korisnika (dob/spol itd.).

Kada planiramo igralište, uvijek radimo sa profesionalnim kontrolnim listama za planiranje, koje također uključuju i važne faktore za izvođenje građevinskih i montažnih radova. Posebni zadaci kao što su koncepti za više generacija, inkluzija, ili npr posebno namjenjeni za kretanje, ali i razne tematske želje prilikom dizajna su uključeni od samog početka u samo planiranje igrališta.

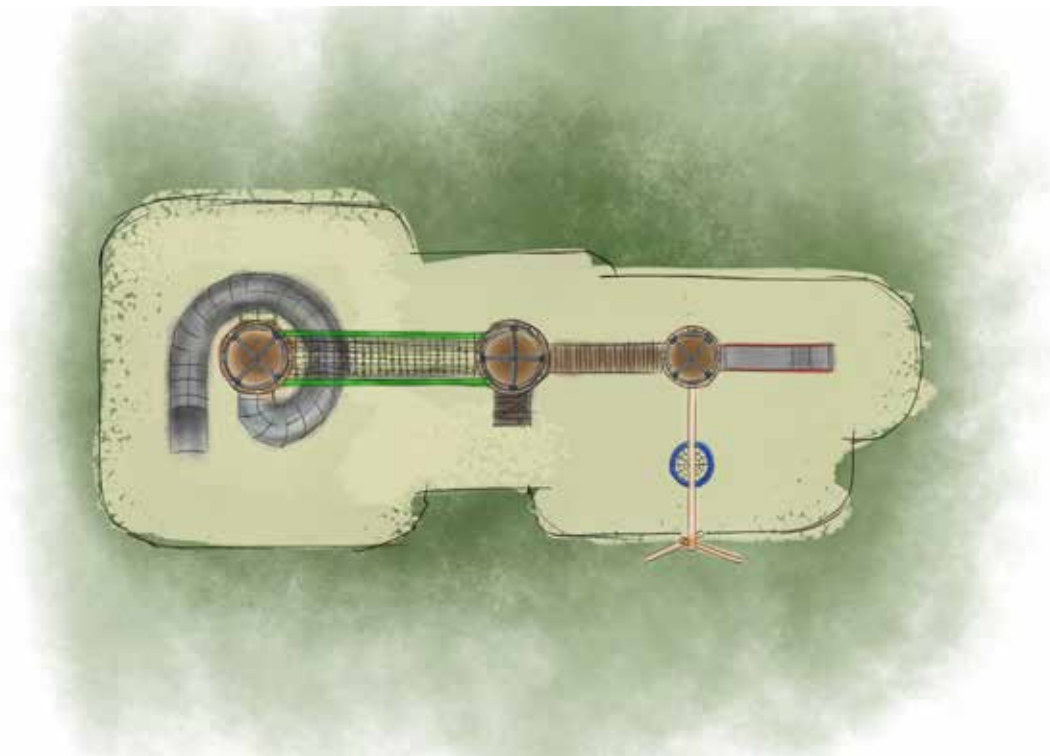

## Grubi koncept

Stvarno planiranje igrališta obično započinje fazom koncepta (mozganje/brainstorming, pronalazak odgovarajuće teme). Kada ugrubo napravimo koncept on obuhvata zoniranje,

funkcionalne zone, planiranje šetnica, prilaza, ulaza na igralište ili cjelokupan park ako se radi o takvoj vrsti ponude.



## Nacrt plana

Na osnovu grubog koncepta kreira se 2D nacrt plana koji kasnije ide u detalje. Nacrt plana takođe uzima u obzir funkcionalna područja za dobne skupine, vrijednosti igre i sigurnosne aspekte/zone. Izbor i pozicioniranje opreme za igralište uvijek

se odvija u kontekstu svih ostalih faktora relevantnih za područje na kojem će biti igralište. Sve je to jako važno, jer kvalitet opreme i sastavnih elemenata igrališta osigurava i konačan kvalitet, učinke na dječiju igru kao i održivost.



## Prezentacija plana igrališta

Od skiciranja slobodnom rukom, preko 2D do 3D vizualizacije. Naši stručni saradnici će vam predstaviti plan igrališta i objasniti konceptualne ciljeve. Tamo gdje je potrebno

i smisleno, za vas možemo predstaviti i pojedinačne dijelove opreme iz naših opsežnih modularnih sistema i ilustrirati ih 3D prikazima.

# Razlozi zbog kojih nam vjeruju prilikom planiranja

Kada je riječ o planiranju igrališta, mi radimo u interdisciplinarnim timovima koji su kompetentni ne samo za planiranje područja gdje će biti smješteno igralište, nego i za cjelokupnu ugradnju, montažu i planiranja troškova. Možete iskoristiti i naše stručno znanje o sigurnosti. Sva

ta područja međusobno povezana prilikom planiranja mogu vam garantirati igralište koje u potpunosti ispunjava sve vaše zahtjeve i ciljne grupe, nudi sigurnost koju možete provjeriti u nadležnom laboratoriju za ispitivanje sigurnosti dječijih igrališta i u potpunosti će vas oduševiti!



**Od ideje do realizacije!**



# NAJVIŠI KVALITET

Od dizajna, preko proizvodnje, sve do otpreme, najviši kvalitet i sigurnost igrališta naš je prioritet na svakom koraku. U proizvodnom procesu upotrebljavamo samo certificirane materijale i više-stepenu kontrolu kvaliteta koja osigurava da svi dijelovi opreme koji napuštaju našu proizvodnju zadovoljavaju stroge sigurnosne norme.

## Najsavremeniji proizvodni procesi

Ponosimo se što možemo djeci, njihovim roditeljima i starateljima dati garanciju bezbrižne zabave i opuštanja na našim igralištima, zahvaljujući strogim procedurama provjere sigurnosti opreme i standardima kvaliteta u okviru naše kompanije.

## Zavarivanje metala

Naše proizvode odlikuje najkvalitetnije i precizno zavarivanje i završna obrada, što garantuje sigurnu upotrebu i trajnost naše opreme za igrališta. Tim visoko kvalifikovanih zavarivača osigurava visoku kvalitetu spojeva čeličnih komponenti (standard EN 3834).



## Zavarivanje tobogana od nehrđajućeg čelika

Cijeli proizvodni proces tobogana od nehrđajućeg čelika izvodi se u našoj proizvodnji. Mi dizajniramo cijev tobogana, zatim ih savijamo visokom preciznošću, te usklađujemo sve komponente i povezujemo ih u izdržljive i sigurno zavarene spojeve.



## Rezanje čelika, savijanje i pjeskarenje

Čelik pripremamo s velikom pažnjom da bi dobili komponente koje su oblikovane tačno u skladu sa zahtjevima dizajna. Čelik se reže zatim savija pomoću modernih CNC mašina za rezanje i savijanje i na kraju površina se adekvatno priprema za završnu obradu cinčanjem ili praškastim farbanjem.

## Cinčanje

Cinčanje je postupak antikorozivne zaštite uglavnom čeličnih dijelova i sklopova. Jedan je od najviše primjenjivanih oblika zaštite od korozije danas, a razlog tako raširenoj primjeni leži u jednostavnosti i isplativosti samog postupka, te dobrim antikorozivnim svojstvima, bez troškova održavanja, tokom gotovo cijelog životnog vijeka proizvoda.



## Pjeskarenje

Čelik koji se koristi u proizvodnji opreme za igrališta se po potrebi podvrgava i procesu čišćenja pjeskarenjem što nam omogućava dobiti odgovarajuću površinu, pa čak i ravne varove i ivice. Pjeskarenje osigurava bolje prijanjanje boje, čime proizvod postaje još sigurniji, izdržljiviji i estetski još ljepši.



## Praškasto farbanje

Naši proizvodi su estetski lijepi i dostupni su u širokom asortimanu boja zahvaljujući savremenom postupku praškastog farbanja. Koristimo najkvalitetnije boje, a sam postupak praškastog farbanja je u skladu sa strogim standardima za temperaturu zagrijavanja boje, debljinom premaza i prijanjanjem boje na čelične elemente.



## Obrada užadi

Koristimo najkvalitetniju čeličnu užad debljine 16 mm obloženu polipropilenskim nitima ili sintetičke pletenice za proizvodnju mreža i užadi za penjanje kao i za mostove. Povezujemo ih čvrstim konektorima od plastike, nehrđajućeg čelika ili aluminijuma. Elementi užadi se mjere i režu na odgovarajuće dužine, a zatim spajaju pomoću hidrauličnih presa pod pritiskom od 150 tona.



## CNC obrada

Ploče od HDPE i HPL nabavljamo od vodećih proizvođača i režemo ih i obrađujemo najsavremenijim CNC mašinama koje garantuju precizno sječenje i pomoću kojih ispunjavamo i najkomplikovanije zahtjeve u dizajnu.



## Obrada drveta

Drvo i drvni materijali se precizno obrađuju prema nominiranim ergonomskim zahtjevima uz racionalno korištenje, najsavremenijim mašinama za obradu drveta, te se uklanjaju sve oštre ivice. U zavisnosti od vrste drveta podvrgava se procesu dubinske impregnacije pod pritiskom.



## Dubinska impregnacija drveta pod pritiskom

Proces koji se odvija pod visokim pritiskom u vakuumu sa sredstvima za zaštitu drveta da vodenoj bazi. Ovaj proces traje više sati i mnogo je bolji od klasičnog metoda impregnacije/zaštite drveta. Impregnacija osigurava dugotrajnu otpornost protiv truljenja, insekata i drugih organizama koji uništavaju drvo, nadživljavajući mnoge prirodno izdržljive vrste drveta u uslovima gdje su izloženi raznim uticajima. Tako obrađeni proizvod imaju vijek trajanja od 10 do 15 godina u slučaju direktnog dodirivanja s tlom. Proizvodi koji nisu u dodiru s tlom imaju životni vijek od 15 do 25 godina.







# MATERIJALI I KOMPONENTE

## Drvo

Koristimo grede vrhunskog kvaliteta, bez čvorova, ujednačene boje i strukture, koje se temeljito obrađuju i u zavisnosti od potrebe i vrste drveta impregniraju. Sve grede su lamelirane, kako bismo izbjegli pucanje greda te produžili vijek trajanja. Na donjem dijelu greda su toplo pocinčani nosači koji štite drvo od direktnog dodira s tlom, čime se produžava njihov životni vijek.

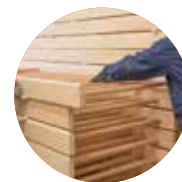

## Čelik

Čelična konstrukcija komponenata igrališta je izrađena od profila različitih presjeka i dimenzija. Koristimo najbolje metode obrade metala postupkom toplog cinčanja ili praškastog farbanja uz prethodnu temeljnu pripremu pjeskarenjem ili hemijskom pripremom.



## Nehrđajući čelik

Nehrđajući čelik koji se koristi za proizvodnju opreme za igrališta, tobogana, cijevnih/zatvorenih tobogana je glatke površine i u potpunosti otporan na sve vremenske uslove, čime se osigurava dug vijek trajanja.



## HDPE

HDPE je visokokvalitetni materijal, polietilen visoke gustoće, otporan na atmosferske utjecaje, tj. vodootporan je, otporan na mraz te UV zrake. Koristimo troslojne ploče za proizvodnju različitih krovova, ogradica i drugih komponenata igrališta.

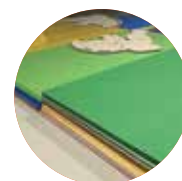

## HPL

su ploče proizvede u laminacionim presama pod visokim pritiskom i temperaturom. Zahvaljujući svojstvima kao što su otpornost na vodu, vlagu, otvoreni plamen, visoku temperaturu te otpornost na utjecaj gljivica i bakterija, HPL ploče su idealan materijal za proizvodnju različitih krovova i ostalih komponenata igrališta.

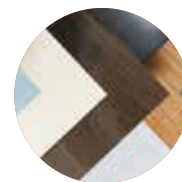



## Protuklizna šperploča

Ima visoku otpornost na habanje, mehanička oštećenja, hemijska sredstva, vlagu itd. Koristi se za izradu platformi kula, zidova za penjanje, platformi na trim stazama.



## Zaštitni poklopci

Gumeni ili polipropilenski zaštitni čepovi štite konstrukcijske profile i spojne vijke od vremenskih uslova kao i djecu od povreda.



## Kamenje za penjanje

Kamenje za penjanje različitih boja od izdržljive kompozitne smole, otporni na habanje i UV zračenje.



## Užad

Polipropilenska užad s čeličnom jezgrom promjera 16mm, povezuju se čvrstim konektorima od plastike, nehrđajućeg čelika ili aluminijuma i koriste za proizvodnju mreža i užadi za penjanje kao i za mostove.



## Vijci

Kvalitetni pocinčani vijci ili od nehrđajućeg čelika također zaštićeni zaštitnim čepovima, čine našu opremu otpornom na habanje, kao i na promjenjive vremenske uslove.

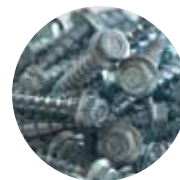

## Ankeri

Zaštićeni postupkom toplog cinčanja štite drvo od direktnog kontakta sa tlom, sprečavajući njegovo truljenje, čime se produžava vijek trajanja i osiguravaju dugogodišnju upotrebu.



## PP tuneli

Tuneli sa dvostrukim zidom otpornim na deformacije, izrađeni od PP (promjer 500 ili 600 mm). Otporan na habanje, vandalizam i vanjske utjecaje.

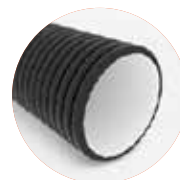

## Lanci

Certifikovani lanci od nehrđajućeg čelika ili toplo cinčani visokog kvaliteta.



## Tobogani

izrađeni od nehrđajućeg čelika (AISI 304), sa bočnim stranama izrađenim od HDPE ili HPL, otporni na vremenske uslove, na vandalizam i spoljne utjecaje.



## Zatvoreni tobogani

Tobogani izrađeni od nehrđajućeg čelika (AISI 304) visokog kvaliteta. Dužina izlaza tobogana ovisi o dužini samog tobogana, a dotupan u više varijanti: ravna, zakrivljena ili spiralna.







# KORIŠTENJE SIMBOLA

Radi lakšega snalaženja naših kupaca, čitalaca kataloga i web shopa uveli smo niz ikona koje opisuju naša igrališta, što podrazumijeva koje sprave (aktivnosti) se mogu odvijati na igralištu, te dodatne ikone za tehnički opis igrališta.

## Aktivnosti na igralištima



Tobogan



Klackalica



Ljuljačka



Most



Mreža



Tunel



Njihalica



Penjalica



Ljestve



Stepenice

## Tehnički opis



Uzrast djece



Kritična visina pada



Dužina / širina / visina igrališta



Sigurnosna zona







**Igrališta koja  
pružaju zabavu,  
učenje i dostupna  
su svakom djetetu!**

**glovis** PLAY

# WOODEN SERIJA

WOODEN serija igrališta je beskrajan izvor inspiracije i zabave kako za mlađu tako i stariju djecu.

Razni edukativni i senzorni paneli, zajedno s pokretnim elementima, privlače mnogo pažnje i djeci donose radost. Ekološki prihvatljiva drvena oprema iz ove serije stimuliše sveobuhvatan fizički razvoj djeteta i omogućava velikoj skupini djece da se igraju zajedno, uspostavljaju odnose sa drugima te funkcionišu unutar tima.

32



Woody classic

36



Woody ecco







38

Robinia

Round woody



42

Kula KMD-2109



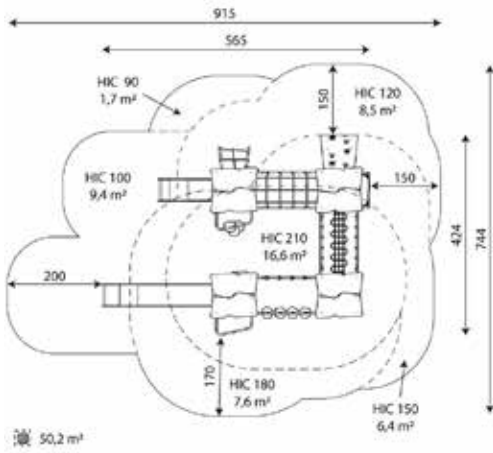

-  3-14
-  5,6x4,2x3,7 m
-  1,8 m
-  50,2 m<sup>2</sup>





**Kula KMD-2100**





-  3-14
-  2x1,4x1,7 m
-  0,9 m
-  18,8 m<sup>2</sup>



**Kula KMD-2101**







-  3-14
-  3,1x1,5x3,1 m
-  1,2 m
-  22,4 m<sup>2</sup>



**Kula KMD-2102**



-  3-14
-  3,3x2,5x3,4 m
-  1,5 m
-  26,4 m<sup>2</sup>



**Kula KMD-2103**





-  3-14
-  3,2x2,5x3,1 m
-  1,2 m
-  26,2 m<sup>2</sup>



**Kula KMD-2104**







-  3-14
-  2,6x2,7x2,8 m
-  0,9 m
-  27,3 m<sup>2</sup>



**Kula KMD-2105**







-  3-14
-  3,6x2,9x3,1 m
-  1,2 m
-  31,1 m<sup>2</sup>



**Kula KMD-2106**







-  3-14
-  4,6x3,5x3,4 m
-  1,9 m
-  37,9 m<sup>2</sup>



**Kula KMD-2107**



-  3-14
-  4x3,3x3,7 m
-  2,2 m
-  40,7 m<sup>2</sup>



**Kula KMD-2108**



-  3-14
-  5,6x3,6x3,7 m
-  1,8 m
-  47,4 m<sup>2</sup>





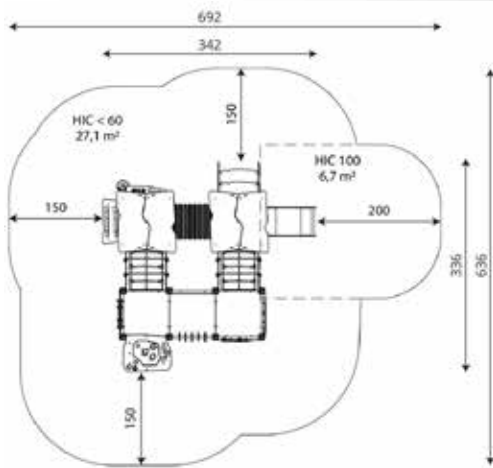

Kula KMB-3205

-  1-8
-  3,4x3,4x2,5 m
-  <0,6 m
-  33,8 m<sup>2</sup>







Kula KMB-3200



-  1-8
-  3,4x3,4x2,5 m
-  <0,6 m
-  33,8 m<sup>2</sup>





Kula KMB-3201



-  1-8
-  3,4x3,4x2,5 m
-  <0,6 m
-  33,8 m<sup>2</sup>

Kula KMB-3202







-  1-8
-  3,4x3,4x2,5 m
-  <0,6 m
-  33,8 m<sup>2</sup>



Kula KMB-3203







-  1-8
-  3,4x3,4x2,5 m
-  <0,6 m
-  33,8 m<sup>2</sup>



Kula KMB-3208



-  1-8
-  3,4x3,4x2,5 m
-  <0,6 m
-  33,8 m<sup>2</sup>



Kula KMB-3209



-  1-8
-  3,4x3,4x2,5 m
-  <0,6 m
-  33,8 m<sup>2</sup>





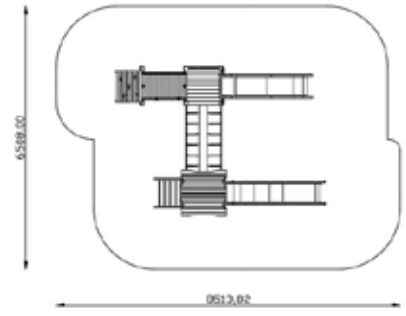

Kula KMD-2200

-  3-14
-  5x3,5x3,4 m
-  1,5 m
-  37,8 m<sup>2</sup>



**Kula KMD-2201**



-  3-14
-  3,3x3,2x3,4 m
-  1,5 m
-  32 m<sup>2</sup>



**Kula KMD-2202**







-  3-14
-  4x1x3,4 m
-  1,5 m
-  24,7 m<sup>2</sup>



**Kula KMD-2203**



-  1-8
-  2,9x3,6x2,6 m
-  0,9 m
-  32 m<sup>2</sup>



**Kula KMD-2204**







-  1-8
-  2,9x1,5x1,7 m
-  0,6 m
-  15,6 m<sup>2</sup>



**Kula KMD-2205**



-  3-14
-  6,5x3,6x3,4 m
-  1,5 m
-  56 m<sup>2</sup>



**Kula KMD-2206**



-  3-14
-  3,5x3,6x3,4 m
-  1,5 m
-  37 m<sup>2</sup>





RB-0010

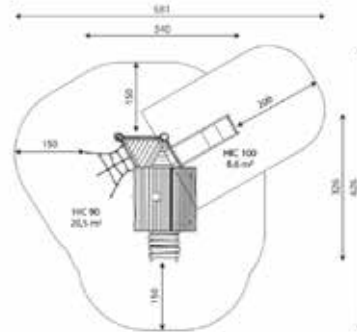

- 2+
- 3,4x3,3x3,1 m
- 0,9 m
- 29,1 m²



RB-0011

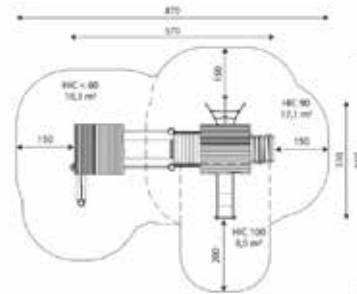

- 2+
- 3,7x3,3x3,1 m
- 0,9 m
- 43,9 m²

RB-0015

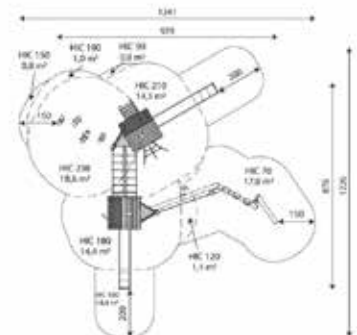

- 5+
- 9,3x8,8x4,3 m
- 2,4 m
- 83,7 m²



**RB-0023**

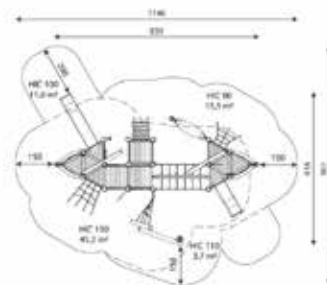

-  3+
-  8,4x6,2x4,6 m
-  1,5 m
-  75,6 m<sup>2</sup>



**RB-0025**

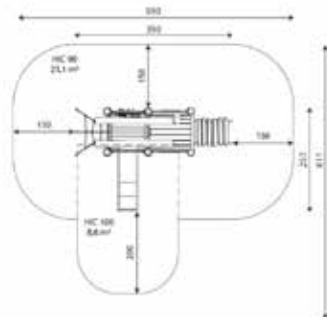

-  2+
-  3,9x2,6x2,0 m
-  0,9 m
-  31,7 m<sup>2</sup>



**RB-0028**

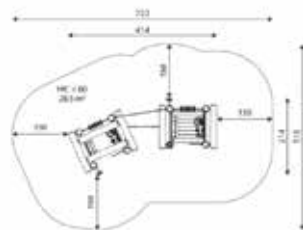

-  1+
-  4,1x2,1x1,6 m
-  <0,6 m
-  20,5 m<sup>2</sup>





RB-0029



RB-0030



RB-0031



RB-0032



RB-0033



RB-0034



RB-0035



RB-0036



RB-0037



RB-0038



RB-0039



RB-0040



RB-0041



RB-0042



RB-0043



RB-0044



RB-0045



RB-0046



RB-0047



RB-0048



RB-0049







RB-0050



RB-0051



Kula RW-0004

-  3-14
-  8,7x7,8x6 m
-  1,5 m
-  127,5 m<sup>2</sup>

Čarobna šuma

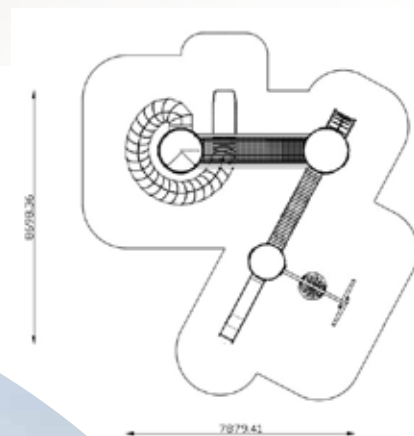

**Kula RW-0001**







-  3-14
-  7,3x3,7x6 m
-  1,5 m
-  50,3 m<sup>2</sup>

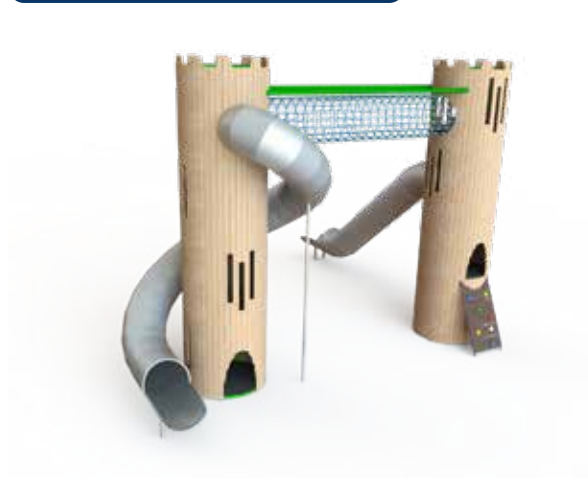

**Kula RW-0002**







-  3-14
-  8,7x8,4x6 m
-  1,5 m
-  146,1 m<sup>2</sup>



**Kula RW-0003**



-  3-14
-  8,7x8,4x6 m
-  1,5 m
-  146,3 m<sup>2</sup>



Kula RW-0005



3-14  
9,9x18,5x3,5 m  
1,5 m  
259 m<sup>2</sup>

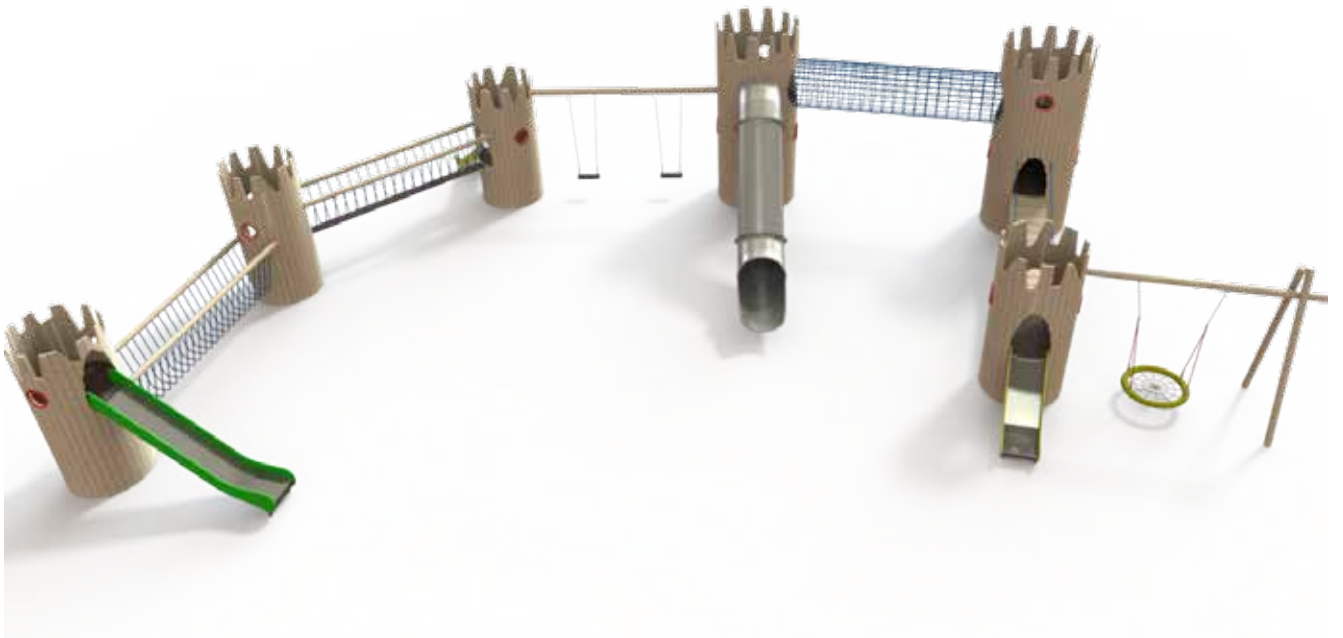





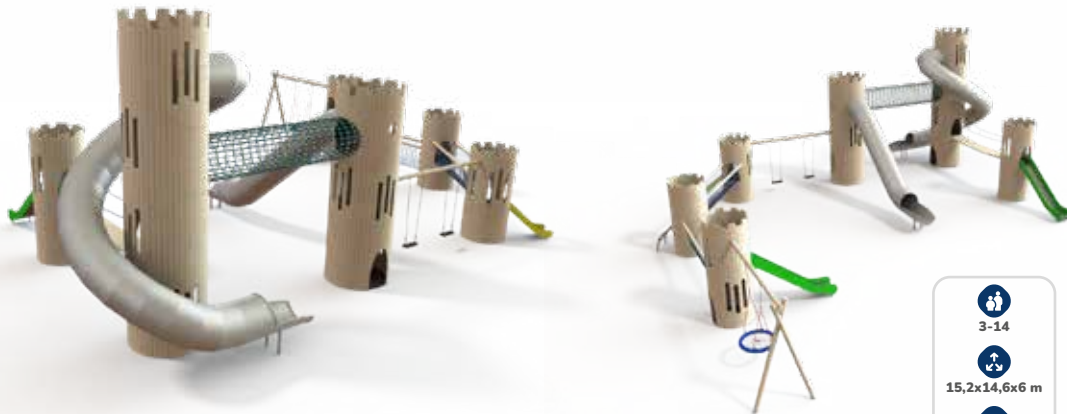

Kula RW-0006

# Dvorac



-  3-14
-  15,2x14,6x6 m
-  1,5 m
-  257 m<sup>2</sup>



Round woody

# STEEL SERIJA

Ovu skupinu igrališta odlikuje jedinstven dizajn i veliki broj edukativnih i inspirativnih funkcionalnosti.

Zabavne, sigurne konstrukcije kula i tematskih cjelina stimulišu maštu i sigurni smo da će mlađoj i starijoj djeci pružiti sate bezbrižne zabave. Tradicionalne čelične konstrukcije kula, koje su omiljene djeci, obogaćene su elementima koji predstavljaju uzbudljive izazove i potiču sveobuhvatan razvoj djece. Linija proizvoda za malu djecu sastoji se od potpuno sigurnog tematskog igrališta i opreme sa brojnim funkcionalnostima, atraktivnim panelima za rukovanje, fenomenalnih boja i privlačnog dizajna koji će nadahnuti maštu svakog mališana.

**Za nas je ključno da se djeca koja koriste naše igralište odlično provode i da se osjećaju sretno. Zato dizajniramo višenamjensku opremu koja je dostupna svakom djetetu i nudi različite oblike zabave.**

Naše igralište nudi i integrativne prostore u kojima se djeca različitih uzrasta i sposobnosti mogu igrati zajedno, što ih zauzvat uči toleranciji i saradnji.





48



Steel classic

56



Steel plus

62







Steel big+



Kula KMP-1112





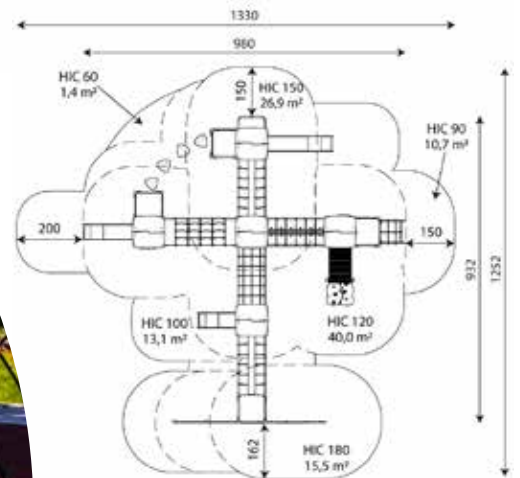

-  3-14
-  9,8x9,3x3,5 m
-  1,8 m
-  107,6 m<sup>2</sup>





**Kula KMP-1100**



-  3-14
-  2,1x1,6x1,8 m
-  0,9 m
-  19,7 m<sup>2</sup>





**Kula KMP-1101**



-  3-14
-  2,8x1,7x3,2 m
-  1,2 m
-  21,6 m<sup>2</sup>





**Kula KMP-1102**



-  3-14
-  2,8x1,9x3,2 m
-  1,2 m
-  24,6 m<sup>2</sup>





**Kula KMP-1103**

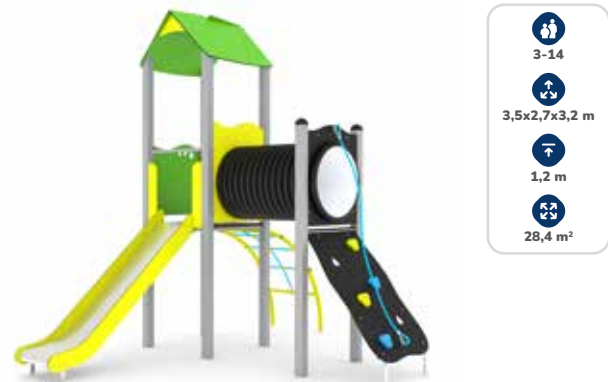

-  3-14
-  3,3x4,0x3,2 m
-  1,2 m
-  36,6 m<sup>2</sup>



**Kula KMP-1104**



-  3-14
-  3,5x2,7x3,2 m
-  1,2 m
-  28,4 m<sup>2</sup>





**Kula KMP-1105**



-  3-14
-  3,4x3,6x3,2 m
-  1,2 m
-  35,0 m<sup>2</sup>

**Kula KMP-1106**



-  3-14
-  4,6x4,0x3,2 m
-  1,8 m
-  38,2 m<sup>2</sup>













**Kula KMP-1107**



-  3-14
-  5,4x3,6x3,5 m
-  1,5 m
-  44,4 m<sup>2</sup>

**Kula KMP-1108**



-  3-14
-  4,4x4,7x3,2 m
-  1,2 m
-  44,1 m<sup>2</sup>

**Kula KMP-1109**



-  3-14
-  6,3x5,6x3,5 m
-  1,5 m
-  59,6 m<sup>2</sup>

**Kula KMP-1110**



-  3-14
-  5,4x4,6x3,2 m
-  2,1 m
-  55,9 m<sup>2</sup>





**Kula KMP-1111**



-  3-14
-  5x4,7x3,5 m
-  1,5 m
-  51,0 m<sup>2</sup>

**Kula KMP-1113**



-  3-14
-  11,5x9,1x4,1 m
-  2,1 m
-  160 m<sup>2</sup>

Kula KMB-3105

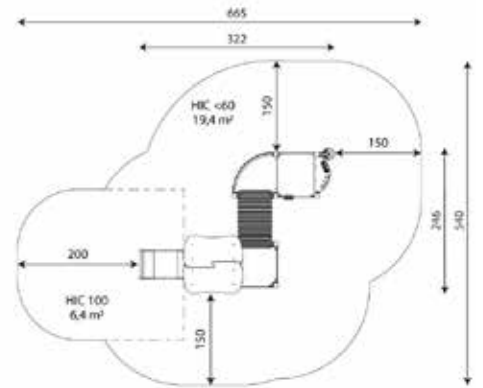



- 1-8
- 3,2x2,5x2,2 m
- <math><0,6</math> m
- 25,8 m<sup>2</sup>



**Kula KMB-3100**



-  1-8
-  1x1x1,7 m
-  <0,6 m
-  13,9 m<sup>2</sup>

**Kula KMB-3101**



-  1-8
-  1x1x1,6 m
-  <0,6 m
-  13,9 m<sup>2</sup>



**Kula KMB-3102**



-  1-8
-  1,6x1x1,7 m
-  <0,6 m
-  15,4 m<sup>2</sup>





**Kula KMB-3103**



-  1-8
-  1,7x1,6x1,7 m
-  <0,6 m
-  17,7 m<sup>2</sup>





**Kula KMB-3104**



-  1-8
-  2,1x1x2,2 m
-  <0,6 m
-  17,9 m<sup>2</sup>





**Kula KMB-3106**



-  1-8
-  3,1x1,7x2,2 m
-  <0,6 m
-  23,3 m<sup>2</sup>

**Kula KMB-3107**



-  1-8
-  2,5x2,4x1,7 m
-  <0,6 m
-  22,9 m<sup>2</sup>

**Kula KMB-3108**







-  1-8
-  3x1,6x1,7 m
-  <0,6 m
-  24,9 m<sup>2</sup>





Kula KMB-3109



-  1-8
-  1,7x1,5x2,2 m
-  <0,6 m
-  18,1 m<sup>2</sup>





Kula KMB-3110



-  1-8
-  2,6x1,6x2,5 m
-  0,9 m
-  20,1 m<sup>2</sup>





Kula KMB-3112



-  1-8
-  2,6x2,5x2,5 m
-  0,9 m
-  26,8 m<sup>2</sup>





Kula KMB-3111



-  1-8
-  3,7x3,2x2,2 m
-  <0,6 m
-  32,9 m<sup>2</sup>





Kula KMB-3113



-  1-8
-  3,3x3,5x2,5 m
-  0,9 m
-  34,9 m<sup>2</sup>





Kula KMB-3114



-  1-8
-  2,5x2x2,4 m
-  <0,6 m
-  21,7 m<sup>2</sup>

Kula KMB-3115



-  1-8
-  4,1x2,8x2,7 m
-  0,9 m
-  30,5 m<sup>2</sup>



Kula KMP-1212





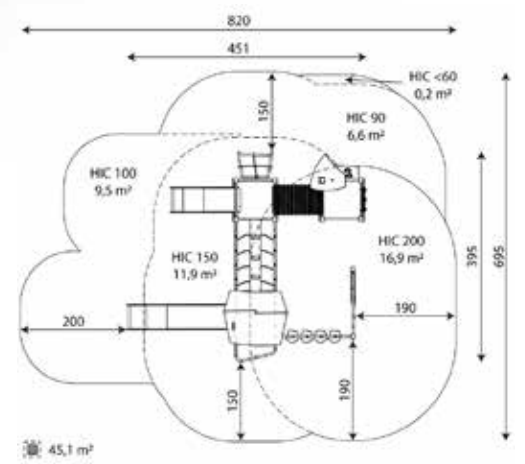

-  3-14
-  4,5x4x3,4 m
-  2 m
-  45,1 m<sup>2</sup>









**Kula KMP-1200**



-  1-8
-  3,1x2,8x2,1 m
-  0,7 m
-  25,3 m<sup>2</sup>





**Kula KMP-1201**



-  1-8
-  2,2x2,3x2,9 m
-  0,9 m
-  22,2 m<sup>2</sup>





**Kula KMP-1202**



-  1-8
-  6,4x5,3x2,3 m
-  1 m
-  53,1 m<sup>2</sup>





**Kula KMP-1203**



-  1-8
-  3,2x3,1x2,8 m
-  0,9 m
-  30,5 m<sup>2</sup>

**Kula KMP-1204**



-  1-8
-  2,8x2,3x3,1 m
-  1,2 m
-  23,9 m<sup>2</sup>



**Kula KMP-1205**



-  3-14
-  4,8x2,2x3,4 m
-  2 m
-  31,7 m<sup>2</sup>

**Kula KMP-1206**



-  3-14
-  3,7x3x3,1 m
-  2,2 m
-  31,5 m<sup>2</sup>

Kula KMP-1207



- 3-14
- 3,6x5x3,1 m
- 2 m
- 40,5 m<sup>2</sup>

Kula KMP-1208



- 3-14
- 5x4,6x3,2 m
- 2 m
- 41,4 m<sup>2</sup>

Kula KMP-1209



- 3-14
- 3,3x2,5x3,2 m
- 2 m
- 29,3 m<sup>2</sup>

Kula KMP-1210



- 3-14
- 3,5x3,3x3,4 m
- 1,5 m
- 31 m<sup>2</sup>

Kula KMP-1211



- 3-14
- 4x3,6x3,7 m
- 2,2 m
- 40,5 m<sup>2</sup>



Kula KMP-1213



- 3-14
- 5,2x3,6x3,7 m
- 1,8 m
- 44,6 m<sup>2</sup>

**Kula KMP-1214**



-  3-14
-  7x3,4x3,7 m
-  2 m
-  55,1 m<sup>2</sup>

**Kula KMP-1215**



-  3-14
-  5,7x4x3,7 m
-  2,2 m
-  52,1 m<sup>2</sup>

**Kula KMP-1216**



-  3-14
-  6,1x3,7x3,4 m
-  2,2 m
-  55,8 m<sup>2</sup>





**Kula KMP-1218**



-  4-14
-  8,5x7,5x4,9 m
-  2,7 m
-  65,5 m<sup>2</sup>

**Kula KMP-1217**



-  4-14
-  5,3x3,7x4,9 m
-  2,7 m
-  44,4 m<sup>2</sup>





Kula KMP-1219



-  4-14
-  7,4x5,5x6,6 m
-  2,7 m
-  51,1 m<sup>2</sup>



Kula KMP-1220



-  4-14
-  11,5x8,1x6,1 m
-  2,7 m
-  89,9 m<sup>2</sup>



Kula KMP-1221



-  4-14
-  10,5x8x9 m
-  2,7 m
-  80,4 m<sup>2</sup>



Kula KMP-1222



-  4-14
-  15,3x13,2x9 m
-  2,7 m
-  139,4 m<sup>2</sup>

**Kula KMP-1223**



-  4-14
-  15,3x15,2x9 m
-  2,7 m
-  173,9 m<sup>2</sup>



**Kula KMP-1224**



-  4-14
-  20,6x20x9 m
-  2,7 m
-  284,6 m<sup>2</sup>

**Kula KMP-1226**



-  4-14
-  12x6x6,4 m
-  2,7 m
-  101,2 m<sup>2</sup>

Kula KMP-1401



- 3-14
- 6.4x4.6x4.2 m
- 1,7 m
- 62,6 m<sup>2</sup>

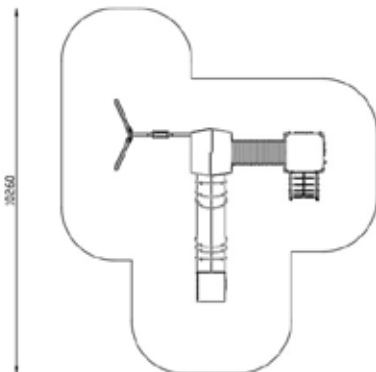



**Kula KMP-1400**



-  3-14
-  3,5x1,2x3,5 m
-  1,5 m
-  24,6 m<sup>2</sup>



**Kula KMP-1402**







-  3-14
-  3,5x2,4x3,5 m
-  1,5 m
-  36,6 m<sup>2</sup>



**Kula KMP-1404**







-  3-14
-  10,6x7,7x3,9 m
-  2,3 m
-  137,1 m<sup>2</sup>









**Kula KMP-1300**



-  3-12
-  2,5x2,6x2,5 m
-  0,9 m
-  24,0 m<sup>2</sup>





**Kula KMP-1301**



-  3-12
-  4,0x3,2x2,9 m
-  1,2 m
-  32,3 m<sup>2</sup>

**Kula KMP-1302**



-  3-12
-  3,3x2,9x2,5 m
-  0,9 m
-  30,3 m<sup>2</sup>





**Kula KMP-1303**



-  3-14
-  4,2x3,3x3,4 m
-  1,8 m
-  33,5 m<sup>2</sup>

**Kula KMP-1304**



-  5-14
-  6,3x3,6x3,4 m
-  1,8 m
-  42,2 m<sup>2</sup>

**Kula KMP-1305**





-  5-14
-  4,5x3,6x3,4 m
-  1,8 m
-  36,1 m<sup>2</sup>







Kula KMP-1306



-  5-14
-  9,7x9,4x3,7 m
-  2,1 m
-  75,6 m<sup>2</sup>





Kula KMP-1307



-  5-14
-  9,7x7,7x3,7 m
-  2,1 m
-  69,6 m<sup>2</sup>





Kula KMP-1309







-  5-14
-  11,2x9,4x3,7 m
-  2,1 m
-  101,2 m<sup>2</sup>



Kula KMP-1311

-  3-14
-  4,3x7,8x4,5 m
-  2,9 m
-  96,3 m<sup>2</sup>



-  5-14
-  6,3x5,5x3,4 m
-  2,5 m
-  42,2 m<sup>2</sup>





# POJEDINAČNE SPRAVE

Da li možete zamisliti igralište bez ... ?



Swingoo



Spinngoo



Springoo



Climboo





79



Solo



Sprave

Ljuljačka MD-0101



- 1-3 / 3-14
- 1,9x3,6x2,4 m
- 1,3 m
- 21,5 m<sup>2</sup>

Ljuljačka MD-0104



- 3-12
- 1,9x3,6x2,4 m
- 1,3 m
- 21,5 m<sup>2</sup>

Ljuljačka MD-0105



- 1-3 / 3-14
- 1,9x2,5x2,4 m
- 1,3 m
- 13 m<sup>2</sup>

Ljuljačka MD-0120



- 1-3 / 3-14
- 1,9x6,2x2,4 m
- 1,3 m
- 40,3 m<sup>2</sup>

Ljuljačka MP-0124







- 3-14
- 4,9x3,1x2,7 m
- 1,3 m
- 13,5 m<sup>2</sup>



Ljuljačka MP-0106



-  1-3 / 3-14
-  1,9x2,5x2,4 m
-  1,3 m
-  13 m<sup>2</sup>



Ljuljačka MP-0107





-  1-3 / 3-14
-  1,9x3,6x2,4 m
-  1,3 m
-  21,5 m<sup>2</sup>



Ljuljačka MP-0110



-  3-12
-  1,9x3,6x2,4 m
-  1,3 m
-  21,5 m<sup>2</sup>

Ljuljačka MP-0112



-  1-3 / 3-14
-  2x6,2x2,4 m
-  1,3 m
-  40,3 m<sup>2</sup>



Ljuljačka MP-0123



-  1+
-  1,9x2,5x2,4 m
-  1,75 m
-  12,9 m<sup>2</sup>

**MOGUĆNOST  
IZBORA SJEDALA**



**BASIC**  
3-14  
GODINA







**BABY**  
1-3  
GODINE









Klackalica MK-0301



-  3-12
-  2,9x0,4x0,7 m
-  0,9 m
-  10,8 m<sup>2</sup>





Klackalica MK-0302

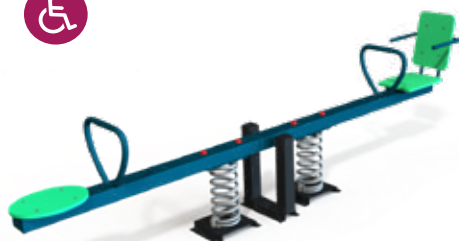

-  3-12
-  2,9x3,8x0,7 m
-  0,9 m
-  21,6 m<sup>2</sup>





Klackalica MK-0303



-  3-12
-  2,4x0,5x0,7 m
-  0,7 m
-  18 m<sup>2</sup>





Klackalica MK-0305



-  3-12
-  2,6x1,1x1,3 m
-  0,6 m
-  22,3 m<sup>2</sup>





Klackalica MK-0306

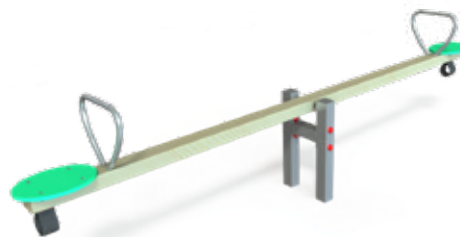

-  3-12
-  2,1x2,4x0,7 m
-  0,5 m
-  17,6 m<sup>2</sup>

Klackalica MK-0309







-  3-12
-  2,9x0,4x0,7 m
-  0,9 m
-  10,8 m<sup>2</sup>





Vrtuljak VMP-0200





-  3-12
-  0,5x0,5x1,4 m
-  <0,6 m
-  15,6 m<sup>2</sup>

Vrtuljak VMP-0201



Vrtuljak VMP-0202



-  3-12
-  1,2x1,2x0,7 m
-  0,7 m
-  21,2 m<sup>2</sup>

Vrtuljak VMP-0203







Vrtuljak VMP-0205







Vrtuljak VMP-0207



-  3-12
-  2,7x2,7x2,4 m
-  0,4 m
-  44,6 m<sup>2</sup>

Vrtuljak VMP-0213







-  3-12
-  0,7x0,7x1,5 m
-  <0,6 m
-  17,6 m<sup>2</sup>









Njihalica HDPE-0400



-  1-12
-  0,8x0,2x0,8 m
-  <0,6 m
-  10,2 m<sup>2</sup>





Njihalica HDPE-0402



-  1-12
-  1,4x0,3x0,8 m
-  <0,6 m
-  12,6 m<sup>2</sup>



Njihalica HDPE-0403



-  1-12
-  1,4x1,2x0,8 m
-  <0,6 m
-  14,2 m<sup>2</sup>





Njihalica HDPE-0404

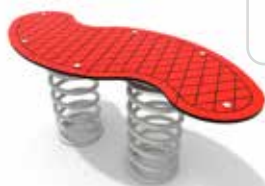

-  1-12
-  0,8x0,4x0,9 m
-  <0,6 m
-  11,1 m<sup>2</sup>

Njihalica HDPE-0406







-  3-12
-  1x,5x0,5 m
-  0,5 m
-  14 m<sup>2</sup>







Mostić MP-0509



-  3-14
-  2,4x0,9x1,2 m
-  <0,6 m
-  19,1 m<sup>2</sup>



Penjalica MP-0501



-  3-14
-  2,2x1,0x2,0 m
-  1,9 m
-  19,8 m<sup>2</sup>





Penjalica MP-0502



-  3-14
-  2,6x1,7x2,0 m
-  1,9 m
-  26,1 m<sup>2</sup>





Penjalica MP-0503



-  3-14
-  3,5x3,1x1,9 m
-  1,8 m
-  30 m<sup>2</sup>





Penjalica MP-0530



-  4-14
-  9,1x9,1x2,2 m
-  2,0 m
-  112 m<sup>2</sup>



Penjalica MP-0531



-  4-14
-  9,2x2,6x2,2 m
-  2,0 m
-  51,3 m<sup>2</sup>





Penjalica MP-0532



-  4-14
-  11,1x9,6x2,2 m
-  2,0 m
-  97,9 m<sup>2</sup>





Trim staza MP-0514



-  3-14
-  5,0x4,0x1,2 m
-  <0,6 m
-  46,9 m<sup>2</sup>





Trim staza MP-0515



-  3-14
-  5,9x4,0x1,2 m
-  <0,6 m
-  57 m<sup>2</sup>

Penjalica MD-0503



-  7-16
-  2,3x1,6x2,0 m
-  1,9 m
-  25,3 m<sup>2</sup>





Penjalica MD-0504

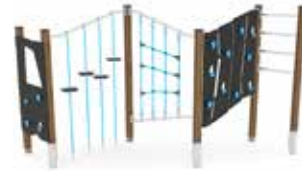

-  3-14
-  1,6x0,9x2,3 m
-  2,2 m
-  22,1 m<sup>2</sup>





Penjalica MD-0505



-  3-14
-  3,1x3,1x2,3 m
-  2,2 m
-  31,3 m<sup>2</sup>





Penjalica MD-0506



-  3-14
-  2,9x2,6x2,0 m
-  1,9 m
-  31,8 m<sup>2</sup>





Penjalica MD-0507



-  3-14
-  2,2x0,9x1,7 m
-  1,0 m
-  18,2 m<sup>2</sup>

Penjalica MD-0508



-  7-16
-  2,9x2,6x2,3 m
-  2,2 m
-  10,8 m<sup>2</sup>



Penjalica MD-0511



-  3-14
-  2,4x2,3x2,3 m
-  2,2 m
-  33,9 m<sup>2</sup>





Penjalica MD-0512



-  3-14
-  5,4x3,1x1,4 m
-  <0,6 m
-  44,7 m<sup>2</sup>

Penjalica MD-0513



-  7-16
-  5,4x3,2x2,3 m
-  2,2 m
-  60,4 m<sup>2</sup>





Penjalica HDPE-0409

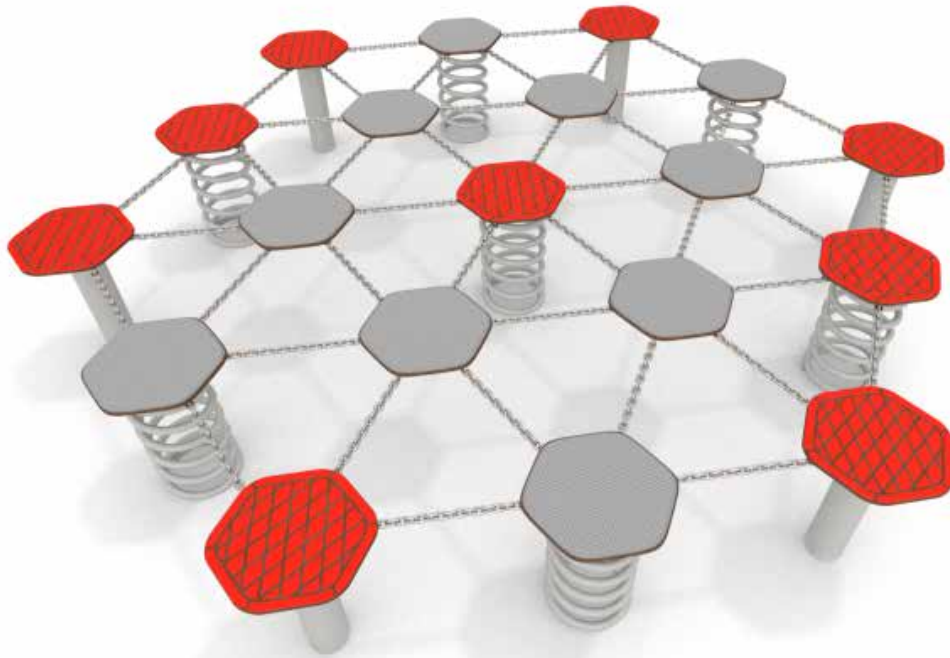





- 3-12
- 2,4x2,7x0,4 m
- 0,4 m
- 30,7 m<sup>2</sup>

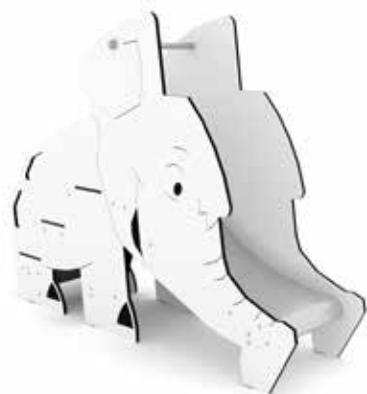



**Tobogan slonić SS-0800**



-  1-8
-  1,8x0,5x1,3 m
-  <0,6 m
-  15 m<sup>2</sup>





**Tobogan kornjača SS-0801**



-  1-8
-  2,0x1,0x0,7 m
-  <0,6 m
-  18,5 m<sup>2</sup>





**Tobogan SS-0802**



-  3-12
-  1,8x0,7x1,8 m
-  <0,6 m
-  15,2 m<sup>2</sup>





**Tobogan SS-0803**



-  3-14
-  2,2x0,7x2,1 m
-  1,2 m
-  16,3 m<sup>2</sup>

**Tobogan SS-0804**



-  3-14
-  2,7x0,7x2,4 m
-  1,5 m
-  17,6 m<sup>2</sup>





Pješčanik SB-0700

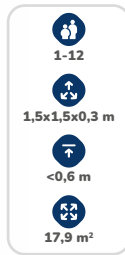

Pješčanik SB-0701



Pješčanik SB-0703

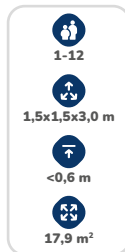

Pješčanik SB-0704

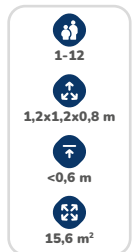



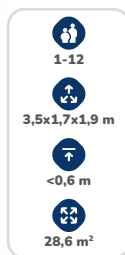

Pješčanik SB-0705









Edukativni panel IP-0800



-  3-12
-  0,9x0,1x1,7 m
-  <0,6 m
-  10,3 m<sup>2</sup>





Edukativni panel IP-0805



-  1-8
-  0,8x0,2x1,3 m
-  <0,6 m
-  10,1 m<sup>2</sup>





Edukativni panel IP-0813

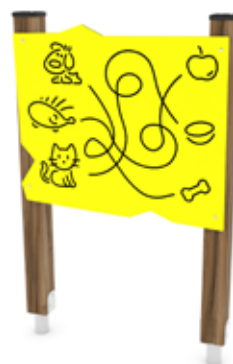

-  1-8
-  2,6x1,1x2,1 m
-  <0,6 m
-  20,2 m<sup>2</sup>





Edukativni panel IP-0817



-  1-8
-  0,8x0,1x1,3 m
-  <0,6 m
-  10 m<sup>2</sup>





Edukativni panel IP-0819



-  1-8
-  0,8x0,1x1,3 m
-  <0,6 m
-  10 m<sup>2</sup>

Edukativni panel IP-0825



-  1-8
-  1,7x1x1,1 m
-  <0,6 m
-  14,5 m<sup>2</sup>

## Autić SO-0801



3-12  
 1,7x1,0x1,0 m  
 <0,6 m  
 17 m<sup>2</sup>

## Kućica SO-0800



1-8  
 1,9x1,4x1,6 m  
 <0,6 m  
 17,6 m<sup>2</sup>

## Vagon SO-0803



3-12  
 1,4x0,9x0,7 m  
 <0,6 m  
 15,4 m<sup>2</sup>

## Penjalica MP-0523

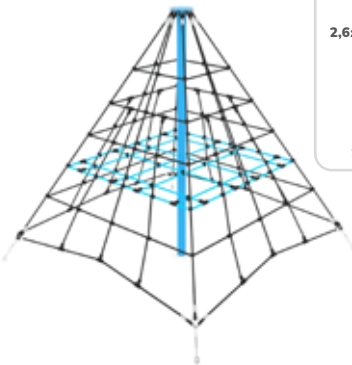

3-14  
 2,6x2,6x2,3 m  
 0,9 m  
 29,6 m<sup>2</sup>

## Penjalica MP-0524

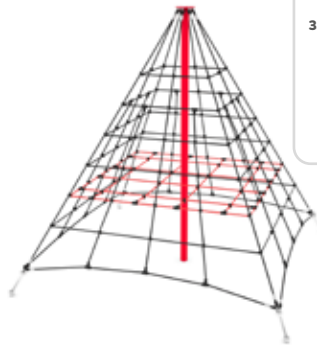

3-14  
 3,1x3,1x3,0 m  
 1,0 m  
 34,7 m<sup>2</sup>

## Penjalica MP-0525

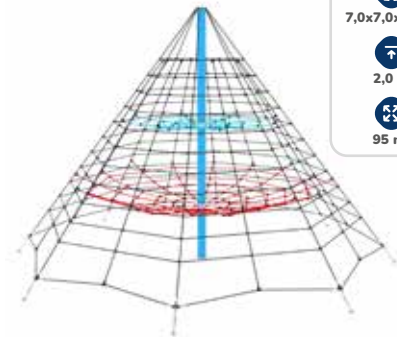

3-14  
 7,0x7,0x4,5 m  
 2,0 m  
 95 m<sup>2</sup>

## Vagon SO-0804



3-12  
 1,3x0,9x1,0 m  
 0,9 m  
 14,8 m<sup>2</sup>

## Vagon SO-0805



3-12  
 1,4x0,9x1,7 m  
 <0,6 m  
 15,4 m<sup>2</sup>

## Vozić SO-0802



3-12  
 1,7x0,9x1,7 m  
 <0,6 m  
 15,4 m<sup>2</sup>







# TOPICOO IGRALIŠTA

Tematska igrališta su vrlo popularna pogotovo kada se uzme u obzir posebnost lokacije i kreativno se integrišu, tada pružaju idealnu osnovu za igru uloga. Bez obzira radi li se o farmi, brodiću ili džungli - tematski fokus igrališta čini ih razigranijima i prepoznatljivijima.

Prednost tematskih igrališta leži u kreativnom osnovnom konceptu koji se jednako sviđa djeci različitih dobnih skupina, a područja igre su pažljivo povezana stazama i mostovima te pružaju mogućnost kretanja, druženja, savdavanja izazova ali i odmora.

Nemamo ograničenjakadajeupitanjukreiranje tematskih igrališta i prostora za igru, nego s ljubavlju osmišljavamo i gradimo sigurna, zanimljiva igrališta kako bi sva djeca radila ono što najbolje znaju-igraju se!









Tvrđava - TP-0904







Kučica - TP-0906



Kučica - TP-0905



Topicoo





Ajfelov toranj - TP-0901

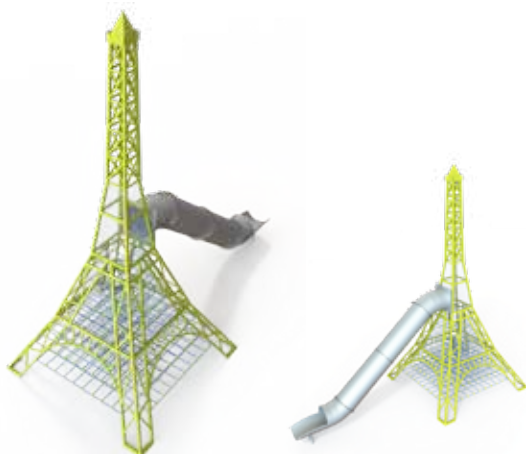

Govornica - TP-0903



Kula Big Ben - TP-0902



London bus - TP-0900



Igralište TP-0900



PRIJEDLOG  
IGRALIŠTA



# GUMENE PODLOGE

Gumene podloge za dječija igrališta, škole, vrtiće, zabavne parkove, sportske terene ili igraonice ne samo da optički poboljšavaju igralište bojama i oblikom nego daju djeci prostora za kreativnost i maštu.

Posjeduju apsorbirajuća svojstva, udobnost, otpornost na sve vremenske uslove. U našem asortimanu naći ćete gumene podloge pogodne za dječija igrališta, koje su proizvedene od vezanog, trajno elastičnog recikliranog gumenog granulata i garantuju najviše sigurnosne standarde na dječjim igralištima.

Osim na dječjim igralištima ove se vrste podloge mogu koristiti u objektima za gimnastiku, penjanje ali i kao trotoari. Postoji mogućnost odabira slova, brojeva i motiva koje su posebno pogodne za projektiranje igrališta u školama, vrtićima, dnevnim centrima, zabavnim parkovima jer vizualno obogaćuju sve sportske i igračke sadržaje.

Prednosti korištenja gumene podloge je maksimalna sigurnost i dug vijek trajanja, dostupnost boja i verzija, odlična drenaža površine, brzina polaganja, instaliranje ploča, mali troškovi održavanja.







Gumene podloge

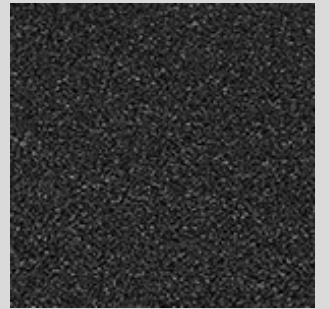
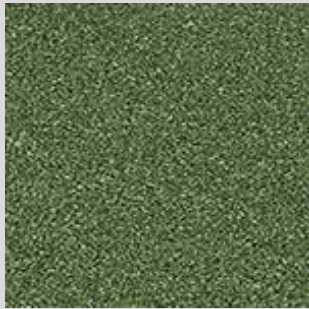
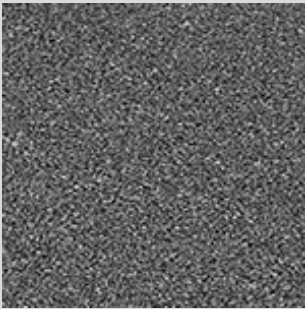
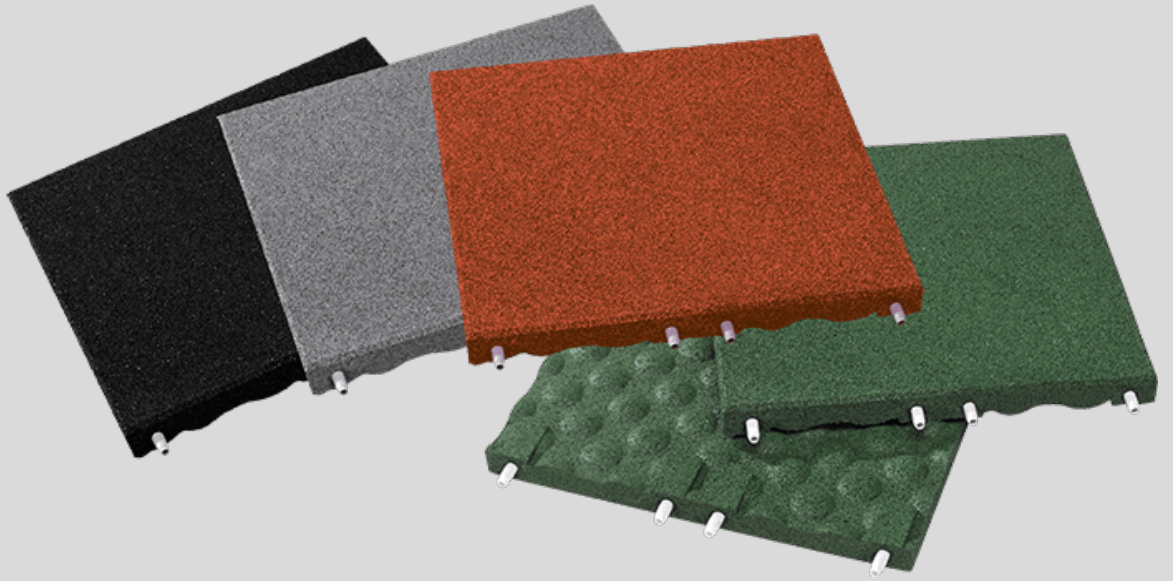

Gumeni oblici

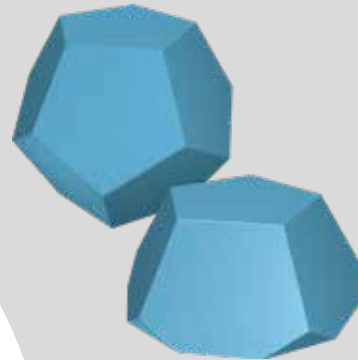
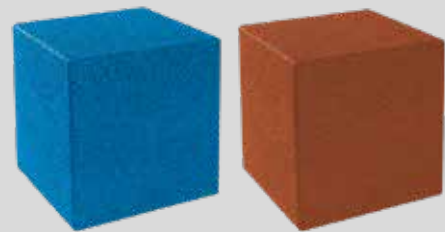



# URBANA OPREMA

Svaka ljudska aktivnost zahtijeva pauzu za odmor i relaksaciju.

Za takve potrebe izrađujemo stolove i klupe s pripadajućim korpama za otpatke te ostalu urbanu opremu koja je sastavni dio svakog paraka i dječijeg igrališta.

Zahvaljujući privlačnom dizajnu i više vrsta modela, naša urbana oprema uklapa se u svaki parkovski prostor u gradu, shopping centru ili stambenom naselju. Pored klupa i stolova u našem proizvodnom asortimanu imamo i autobuska stajališta, prodajne štandove, biciklistička stajališta, te razne druge elemente koji su potrebni za uređenje urbanog prostora.







Klupa KL-1102



Klupa KL-1103



Klupa KL-1104



Klupa KL-1105



Klupa KL-1106



Klupa KL-1107



Klupa KL-1108



Klupa KL-1109



Klupa KL-1110



Klupa KL-1111



Klupa KL-1112



Klupa KL-1113



**Klupa KL-1114**



**Klupa KL-1115**



**Klupa KL-1116**



**Klupa KL-1118**



**Klupa KL-1119**



**Klupa KL-1121**



**Klupa KL-1122**



**Klupa KL-1123**





Klupa KL-1124



Klupa KL-1125



Klupa KL-1126



Klupa KL-1127



Klupa KL-1128

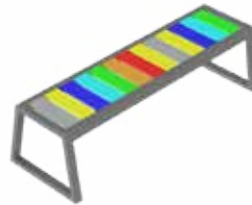

Klupa KL-1129

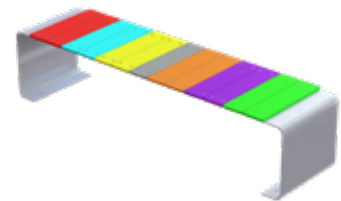

Klupa KL-1130



Klupa KL-1131



Klupa KL-1132



Set za sjedenje s naslonom



Set za sjedenje

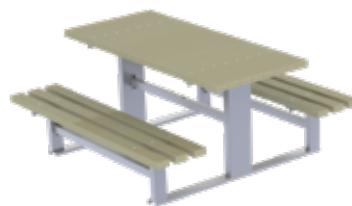

Set za sjedenje HDPE

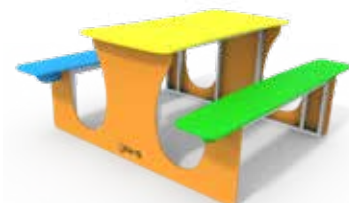

Sto ST-1301



Sto ST-1302



Sto ST-1303



Sto ST-1304



Sto ST-1305



Šadrvan SH-002



Baby svlačionica



Biciklističko stajalište - BS-1403



Biciklističko stajalište - BS-1400



Biciklističko stajalište - BS-1402

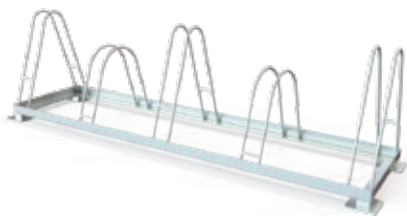

Biciklističko stajalište - BS-1401



Biciklističko stajalište - BS-1404



Biciklističko stajalište - BS-1405





**Korpa KO-1201**



**Korpa KO-1203**



**Korpa KO-1204**



**Korpa KO-1205**



**Korpa KO-1206**



**Korpa KO-1207**



**Korpa KO-1208**



**Korpa KO-1209**



**Korpa KO-1210**



**Korpa KO-1211**



**Korpa KO-1212**



**Korpa KO-1213**



**Korpa KO-1214**



**Korpa KO-1215**



# SPORTSKA OPREMA

## Vježbanje na otvorenom za tijelo i um

Kretanje i fizička aktivnost nužni su za tijelo i dobro zdravlje. Svaki organ, funkcija i proces u organizmu trebaju energiju koja proizlazi iz pokreta. Posebno je važno kretanje i fizičke vježbe u današnje stresno vrijeme uz sjedilački način života.

Glovis sportske i fitness sprave omogućuju svima zabavno vježbanje na otvorenome, bez obzira na uzrast i kondiciju. Bez obzira da li je riječ o vježbi na balans gredi, klupi za vježbanje ili bilo kojoj fitness spravi dobar je osjećaj nakon odrađenog treninga neprocjenjiv.









FSM - 0100



FSM - 0101



FSM - 0102



FSM - 0103



FSM - 0104



FSM - 0105



FSM - 0106



FSM - 0106s



FSM - 0107



FSM - 0108



FSM - 0109



FSM - 0112

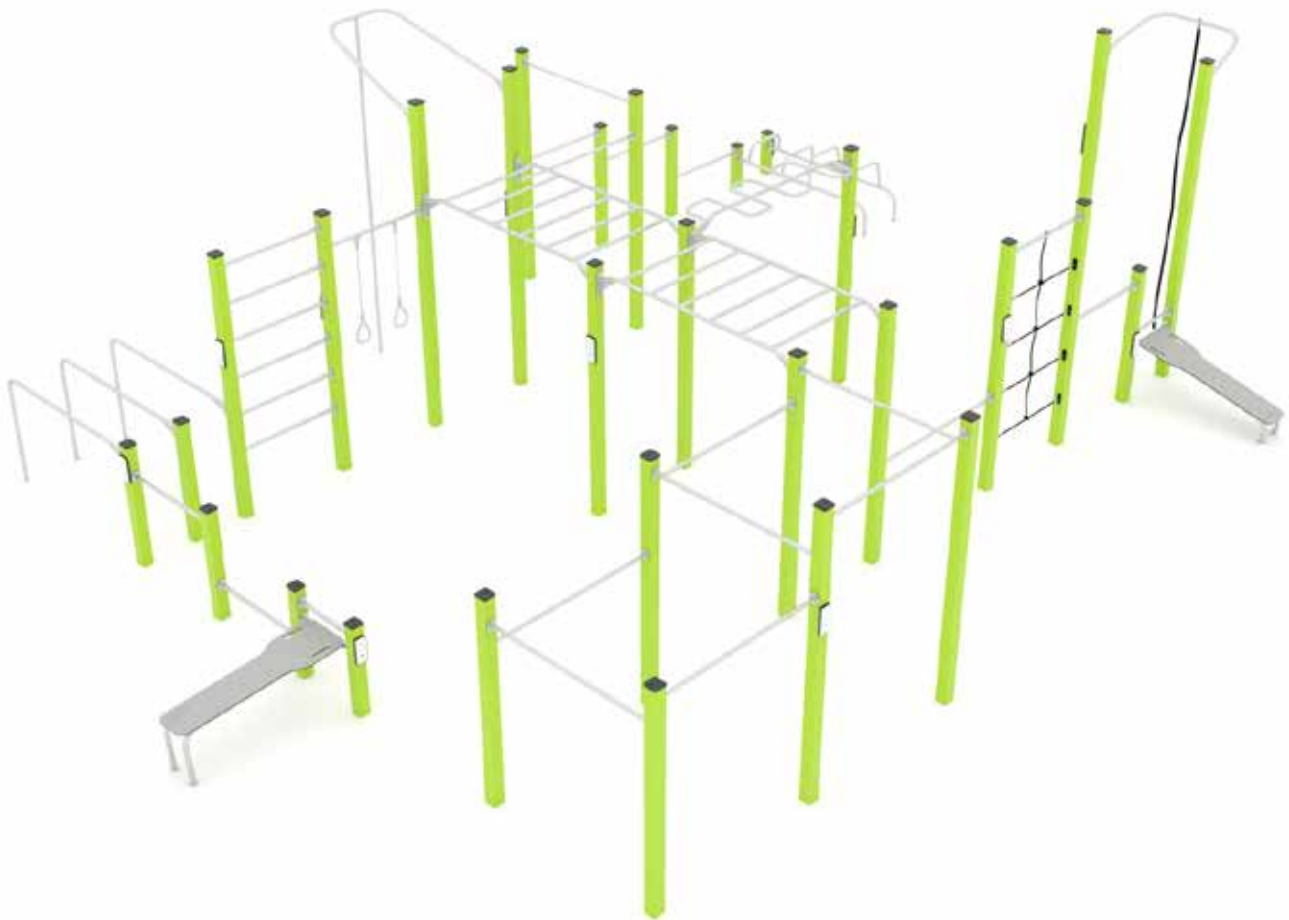

FSM - 0110



FSM - 0111



Balans greda FSD-0208

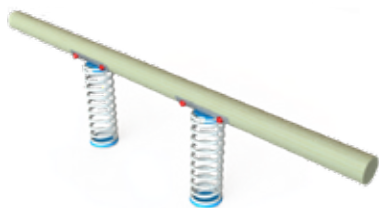

Fit station FSD-0200

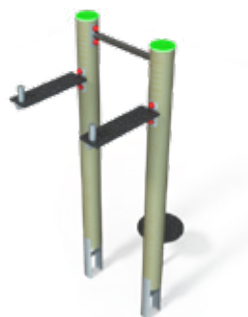

Gym rings FSD-0206

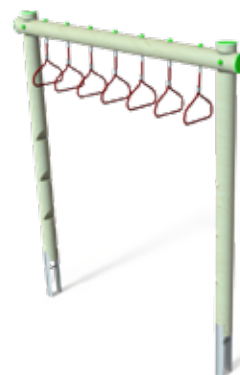

FSD-0210

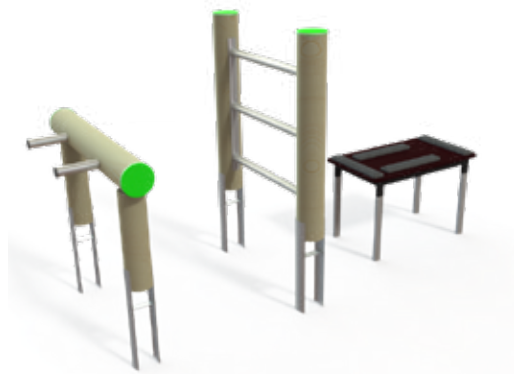

L vratilo FSD-0203



Mini gym rings FSD-0207





Mini monkey bars FSD-0205



Mini razboj FSD-0202

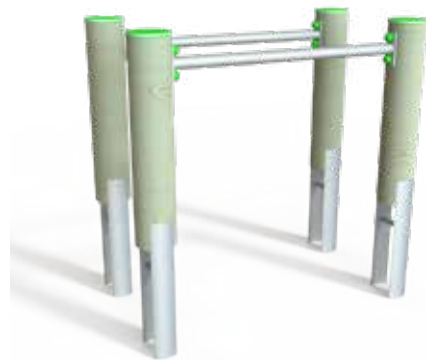

Monkey bars FSD-0204



Razboj FSD-0201

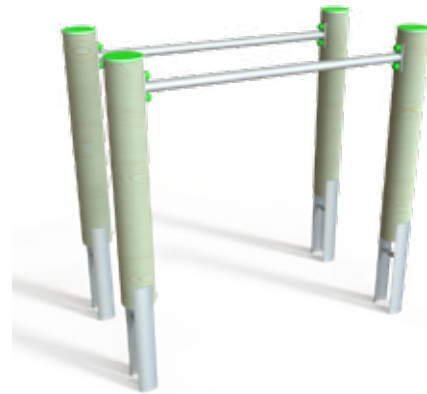

Streetworkout FSD-0211

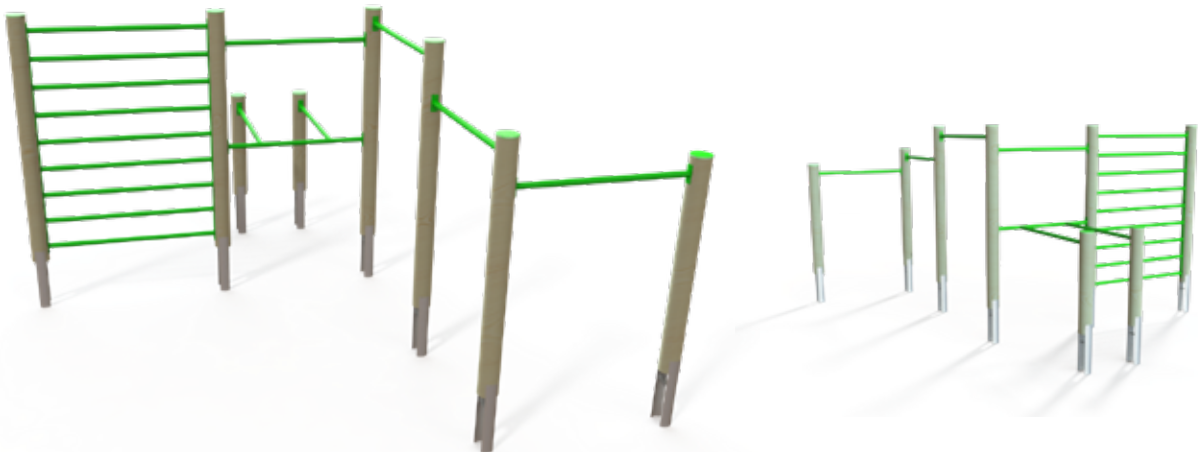





**Dječije  
igralište  
Smetovi**





Platforma za  
digitalizaciju  
održavanja  
dječijih igrališta



**glovis** 

**GLOVIS d.o.o. Zenica**

Zmaja od Bosne b.b. - Poslovna zona Zenica I  
Zenica 72000, Bosna i Hercegovina

Telefon: **032 200 790**

**info@glovis.ba**

**www.glovis.ba**

Pratite nas!



**glovis** PLAY







Finansira Evropska unija



german  
cooperation

DEUTSCHE ZUSAMMENARBEIT



Ova publikacija je urađena uz finansijsku podršku Evropske unije i Saveznog ministarstva za ekonomsku saradnju i razvoj Republike Njemačke (BMZ). Sadržaj ove publikacije je isključiva odgovornost Glovis d.o.o. Zenica i nužno ne odražava stanovišta Evropske unije ili BMZ-a.

Implementiraju:



International  
Labour  
Organization

