

glovis 

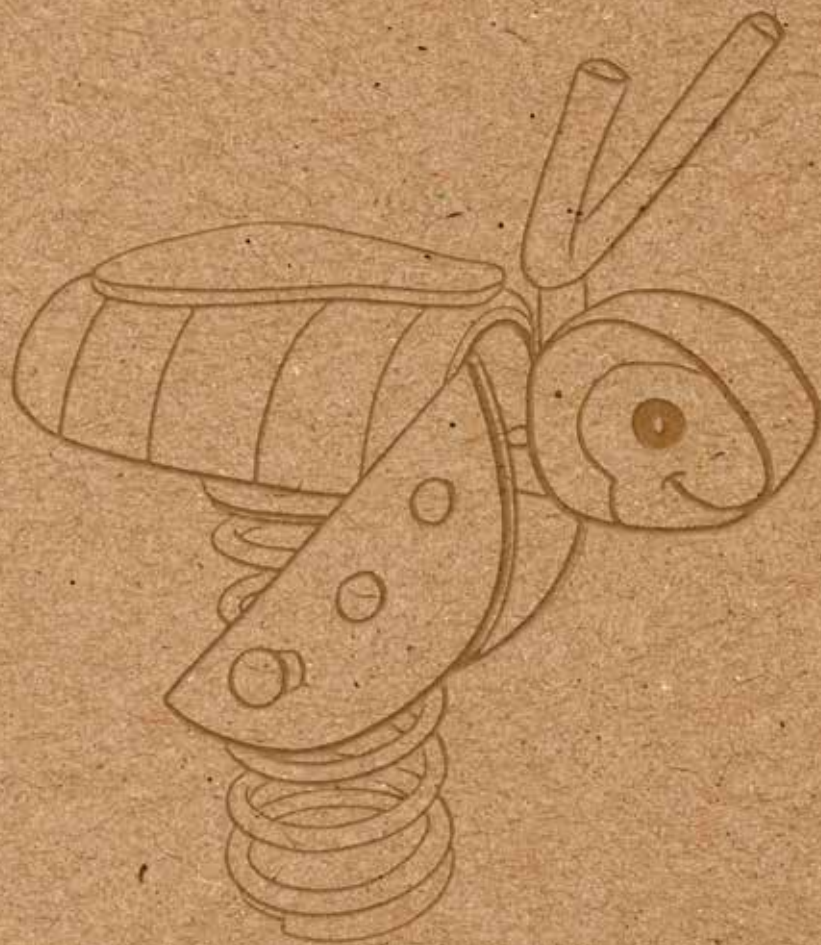

robinia

OD VIJUGAVIH LINIJA PA RAVNO DO ZABAVE ZA DJECU!

Znajući pravu vrijednost dječije igre i na temelju znanja našeg tima, nastojimo pomoći djeci da na najbolji način iskoriste svoje vrijeme na našim igralištima. Naš dizajn serije igrališta od bagrema je inspirisan napravnim oblicima same prirode i jedinstvenošću vijugavog drveta bagrema. Kroz naš dizajn nastojimo potaknuti dječiji interes za prirodu, stvoriti siguran prostor za igru, biti apsolutno posvećeni svakoj fazi izrade dječijeg igrališta, od planiranja do ugradnje.

Prilikom proizvodnje odabiremo samo najfinije drvo bagrema i koristimo samo najizdržljivije drvo u našoj proizvodnji. Naši proizvodi i oprema su proizvedeni u skladu sa standardima za sigurnost dječijih igrališta.

NAŠ CILJ:

Svaka grupa korisnika igrališta je jedinstvena, kao i svako potencijalno mjesto igrališta. Naš primarni cilj je osigurati da svako igralište bude jedinstveno prilagođeno zahtjevima kupca. Naš multidisciplinarni tim savjetnika, dizajnera i planera i drugih stručnjaka rade po unaprijed određenom procesu planiranja. Blisko surađujući s kupcem, kao rezultat dobijemo u potpunosti originalno, prilagođeno dizajnirano rješenje igrališta koje pruža najveću moguću vrijednost za određene korisnike igrališta, za samo mjesto i kupca.

Kako bismo dobili najbolje rješenje na naručioca, uvijek promatramo pet različitih karakteristika igrališta:

- > Karakteristike potencijalnih korisnika (najčešće dob)
- > Vještine i iskustvo koje djeca prilikom igre treba da steknu na igralištu
- > Lokacija igrališta i neposredna okolina, prirodne karakteristike terena
- > Zoniranje igrališta/podjela igrališta u zone koje bi podržavale različite vrste igre
- > Koju opremu za igru ili druge aktivnosti treba integrirati u svaki prostor kako bi se stimulisala dječja igra i kompetencije.

DRVO BAGREMA

Ekološki prihvatljivo, drvo bagrema ima visok sadržaj prirodnih zaštitnih sredstava, stoga ga nije potrebno tretirati protiv truleži na bilo koji način, a u isto vrijeme njegov gusti sastav čini ga vrlo otpornim na pucanje i prodiranje vode i vlage. Njegova snaga, izdržljivost i fleksibilnost ga čine idealnim za korištenje na prirodnim igralištima. Njegova prekrasna zrnasta struktura, sirova oguljena debla i prirodan, rustikalan izgled čine ga izuzetno privlačnim.

Stoga, kombinacija njegovog prirodnog izgleda i izgleda naših igrališta koja su specifično dizajnirana prema vrsti materijala stvaraju izuzetan vizuelni dojam i autentičnost rješenju određenog igrališta. Budući da drvo bagrema ne raste ravno, njegovi vijugavi oblici savršeni su za stvaranje jedinstvene opreme za igru koja se savršeno stapa s prirodom ili čak kao takva pruža mogućnost da se priroda dovede u urbano okruženje.

LET'S PLAY IT GREEN

Naša igrališta odnosno sprave od bagrema su dostupna u više varijanti:

- 1. kao netretirano drvo,**
- 2. tretirano transparentnim premazima**
- 3. sa dijelovima ili detaljima u određenim bojama.**

Boja koju koristimo je ekološki prihvatljiva akrilna boja na bazi vode, koja zadovoljava evropske norme koje određuju sigurnosne zahtjeve za dječija igrališta kada je u pitanju bojenje.



KUĆICE ZA IGRU

Kućica za igru je idealno mjesto za maštovitu igru mališana. Ukoliko se tu dodaju stolovi, klupe i drugi elementi, dobiva se idealno mjesto za igru uloga i druženje u malim grupama.

Prednosti: Razvija društvene i jezične vještine, omogućuje raznoliku igru u malom prostoru, pruža dobrodošlicu maloj djeci i njihovim roditeljima i pruža polazište za širok raspon maštovitih igara.

TOBOGANI

Djeca vole klasične tobogane, koji im pružaju zabavu i brzo ali sigurno slijetanje i već su spremni za novi uzlet. Na ovoj stranici možete vidjeti raznoliku ponudu naših tobogana za sve dobne skupine.

Prednosti: Razvija dječje vještine saradnje, pomaže djeci razumjeti „uzrok i posljedicu“, gradi djetetovo samopouzdanje u vezi s visinom i gravitacijom, a privlačno je mnogim dobnim skupinama.

KULE ZA IGRU

Kule za igru pružaju beskrajne mogućnosti za maštovitu igru, uzbuđenje, potiču kretanje i druženje s prijateljima.

Prednosti: Daje razne mogućnosti za zabavu s mogućnošću učenja i socijalizacije i potiču sveobuhvatan razvoj djece.



RB - 0011



2+



5,8x3,4 m



3,85 m



45 m²

8,8 m

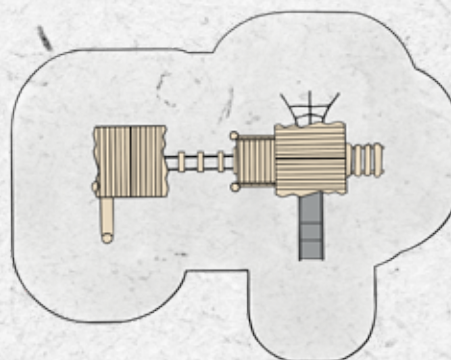

6,9 m

Robinia

RB - 0012



↑ ↓
6,3x5,6 m

↑ ↓
4,35 m

↖ ↗
↘ ↙
50,2 m²

10,5 m

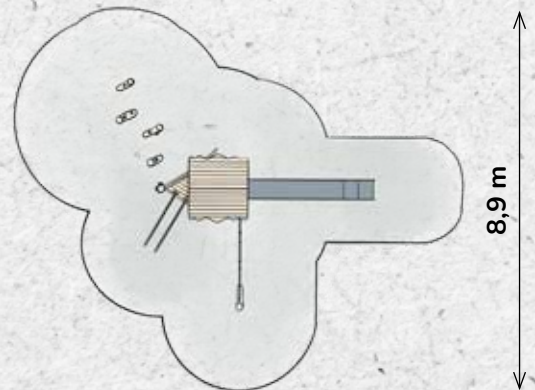

RB - 0146

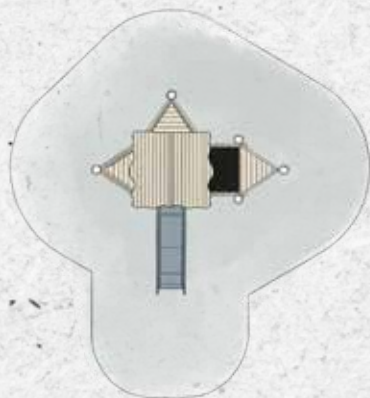

3+



3,6x3,5 m



3 m



48 m²

Robinia

RB - 0008



2+



3,4x2,2 m



3,15 m



26,7 m²

6,4 m

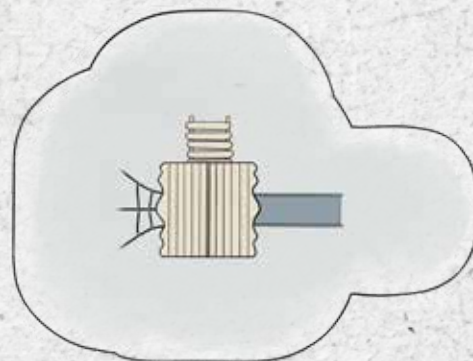

5,2 m

RB - 0015



11,9 m

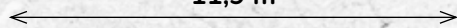

12,5 m

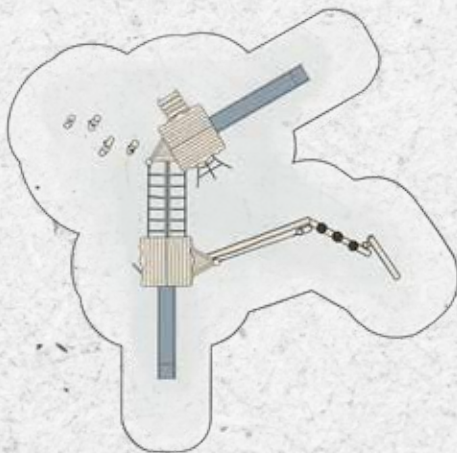
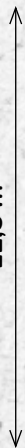

5+



9,5x8,9 m



4,35 m



84,3 m²

RB - 0022

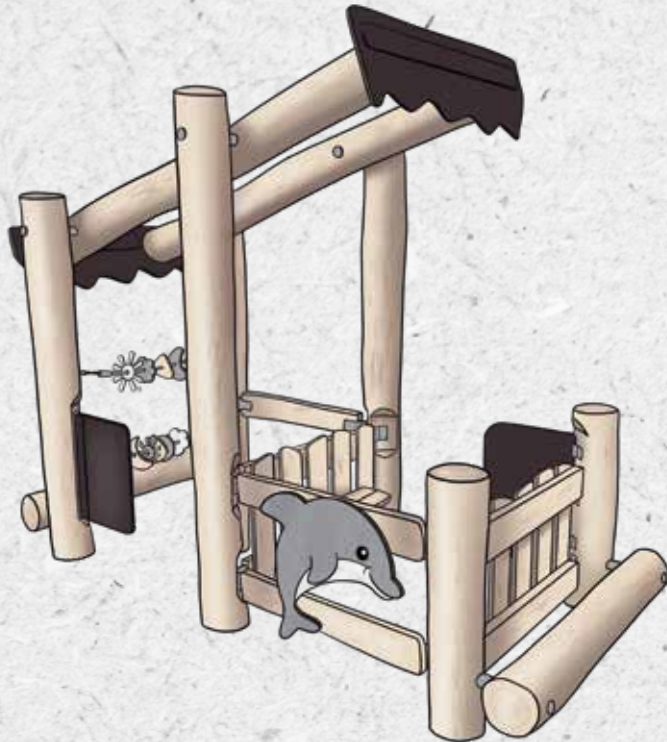

1+



2,75x1,3 m



2,1 m



22,8 m²

5,75 m

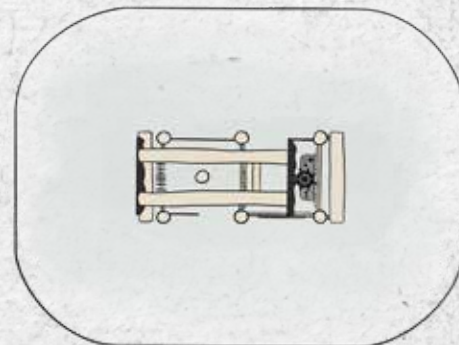

4,3 m



Robinia

KONSTRUKCIJE I MREŽE ZA PENJANJE

Izvrсна aktivnost za rješavanje stresa, na kojima možete bolje upoznati sebe, kretati se i poboljšati svoje sposobnosti. Mogućnosti konstrukcija koje možemo pružiti su neograničene, od brodova, tvrđava do čarobnih kućica iz bajke. Prednosti: Razvija svijest o prostoru, pruža izazove u igri za različite dobi i sposobnosti.

BALANS GREDE

Igra na balans gredama je jako zanimljiva, a treniranje ravnoteže i koordinacije na ovim sprava se svima čini lakim i zabavnim. Različiti izazovi, brojne aktivnosti na malom prostoru, aktivnosti za široku dobnu skupinu, stapa se s okolinom i podržava lokalnu politiku iskorištavanja slobodnog vremena i promocije zdravlja svakog pojedinca.

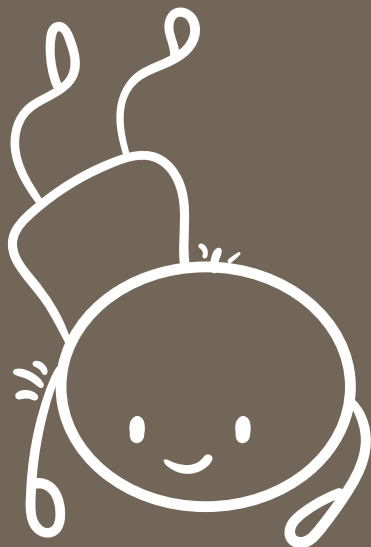

RB - 0126

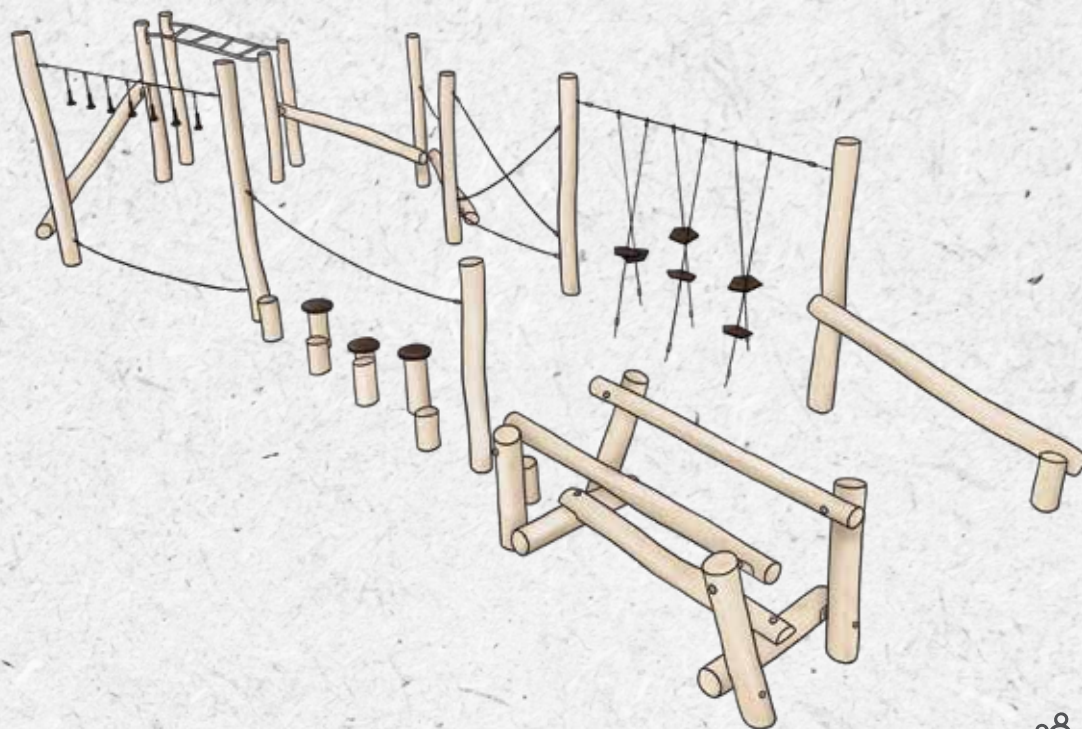

16,3 m

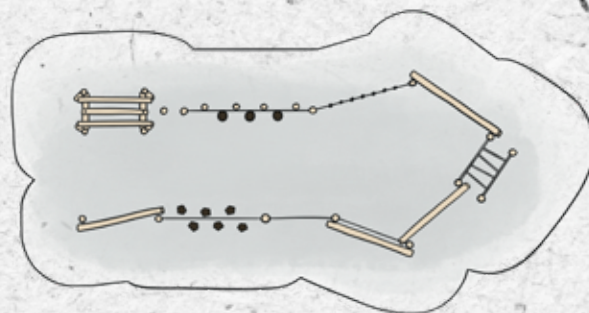

13,4 m



5+



12,25x5,2 m



2,45 m



98,5 m²

RB - 0128



15,85 m

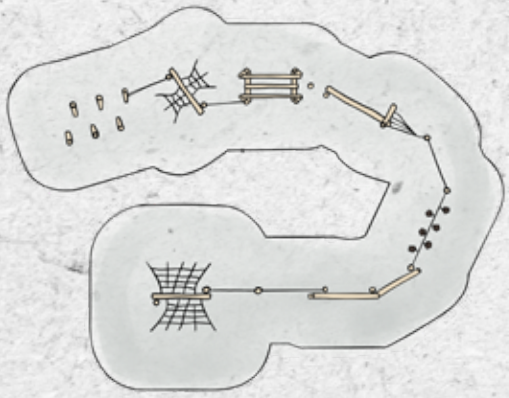

8,2 m



6+



13,3x9,4 m



2,95 m



132,8 m²

RB - 0064

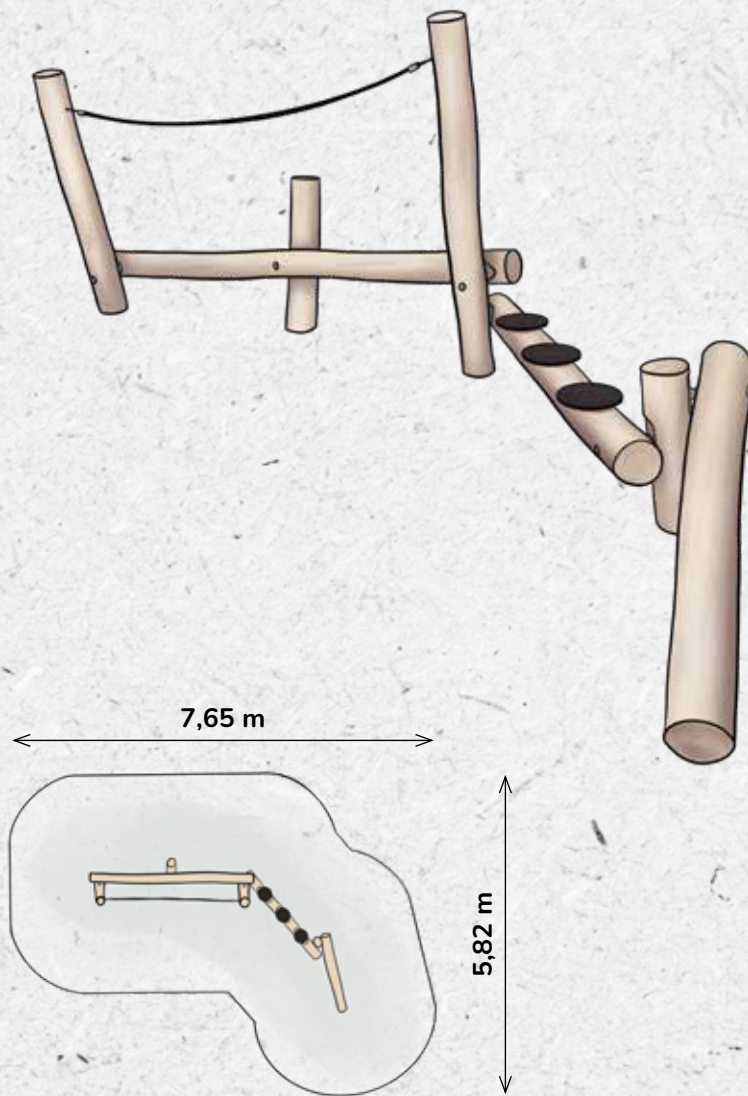

3+



4,65x2,82 m



1,78 m



31,2 m²

Robinia

RB - 0030

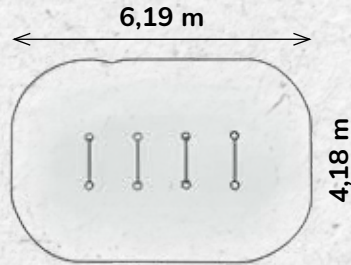
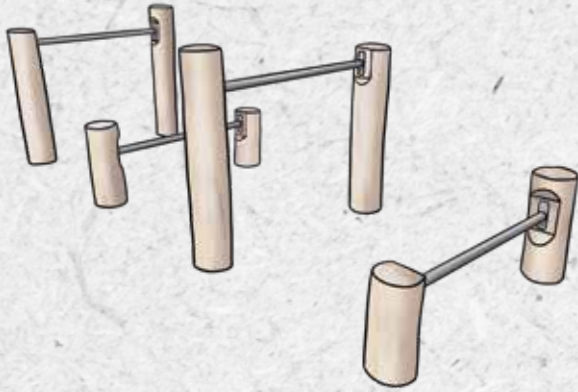

3+



3,19x1,18 m



0,95 m



23,9 m²

RB - 0037

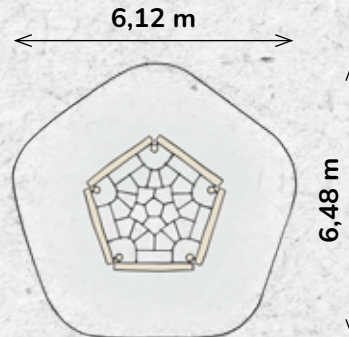
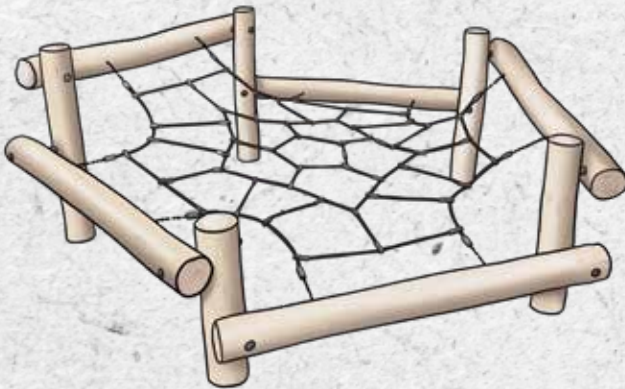

3+



3,28x3,12 m



1,14 m



31,3 m²

RB - 0038



5,81 m

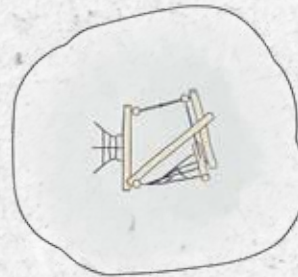

5,32 m



4+



2,81x2,32 m



2,0 m



33,2 m²

RB - 0040

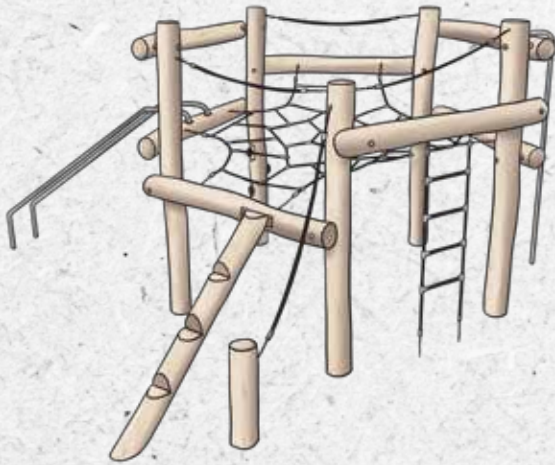

7,4 m

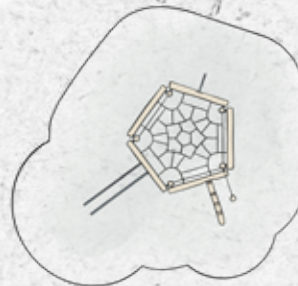

7,4 m



5+



4,4x4,4 m



2,4 m



53,5 m²

Robinia

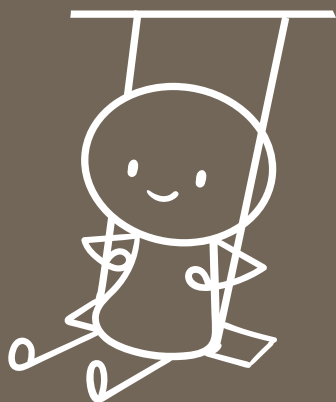

NJIHALICE

Njihalice je nezaobilazna stavka na svakom klasičnom dječijem igralištu koje svojim dizajnom i mogućnošću kretanja uvijek privuče veliki broj djece.

Prednosti: Oprema kojom se lako upravlja i koja razvija mototičke sposobnosti kod djece i pomaže im razumjeti „uzrok i posljedicu“.

LJULJAČKE

Mnogima omiljena za sva vremena. Ljuljačke su popularan i čest izbor za svako igralište. Naše ljuljačke dolaze u različitim izvedbama kako bi se prilagodile djeci svih dobi i sposobnosti. Prednosti: Razvija osjećaj za ravnotežu i „uzrok i posljedicu“, podržava preuzimanje rizika, popularna sprava među djevojčicama i dječacima te podržava društvenu igru.

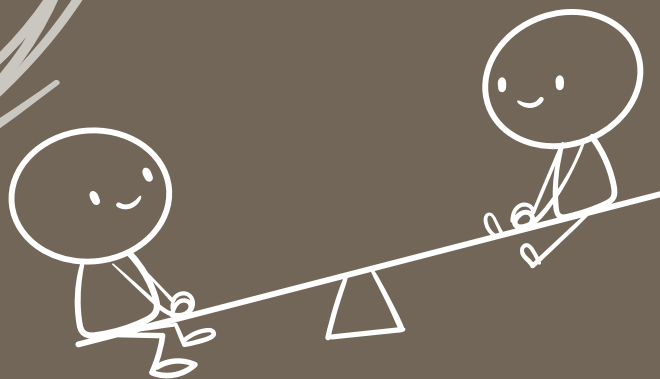

RB - 0104

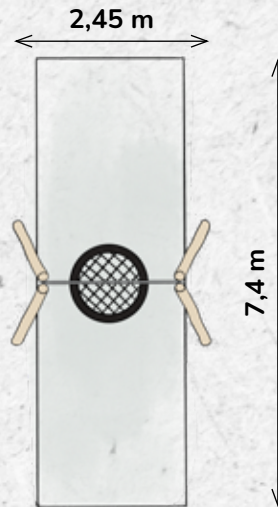

3-12

2,05x3,27 m

2,38 m

18,1 m²

RB - 0103

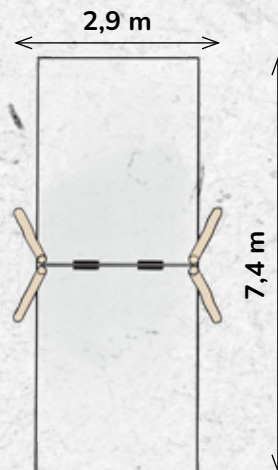

3-14

2,05x3,7 m

2,38 m

21,5 m²

Robinia

RB - 0086

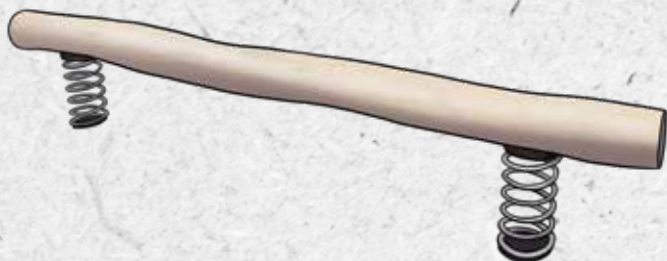

6,25 m

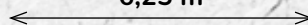

3,22 m

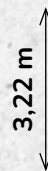

1-12



3,25x0,22 m



0,59 m



18,8 m²

RB - 0100

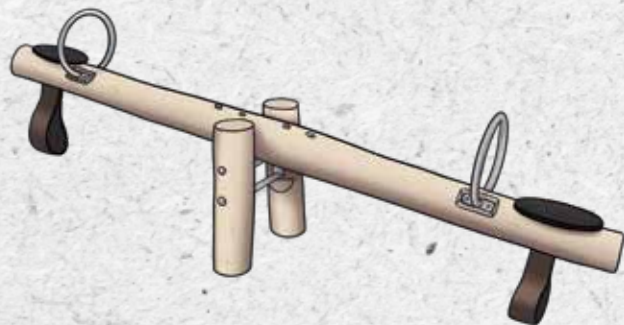

6,2 m

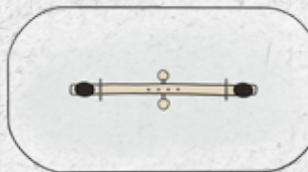
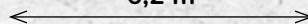

3,64 m

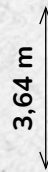

3-14



3,2x0,64 m



0,96 m



13,4 m²

RB - 0085

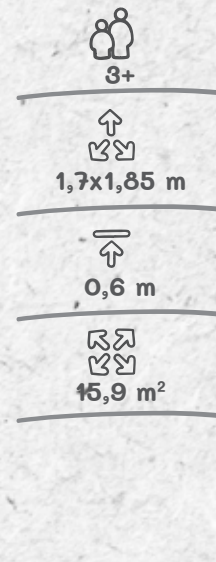
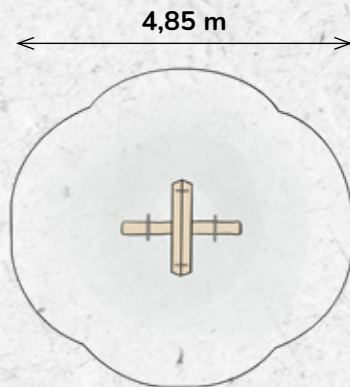
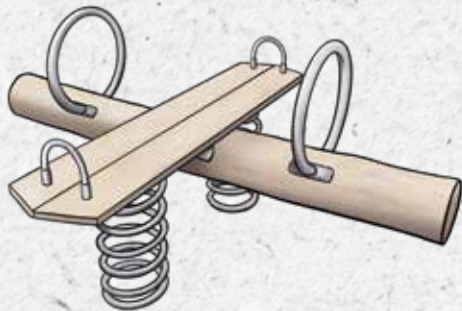

RB - 0087

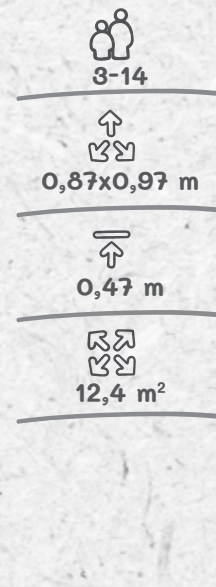
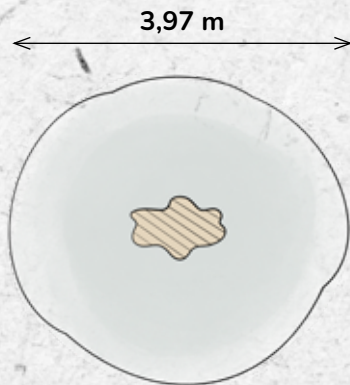

RB - 0147

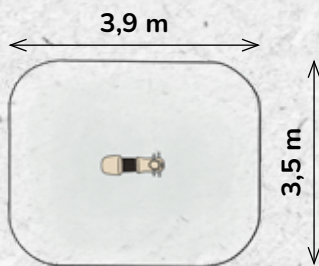
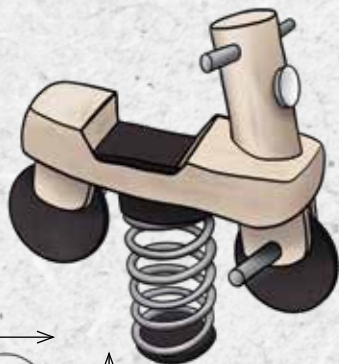

RB - 0148

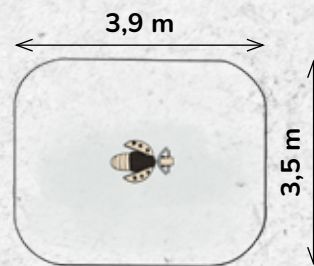

RB - 0149

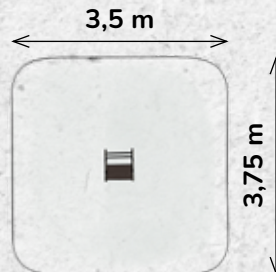

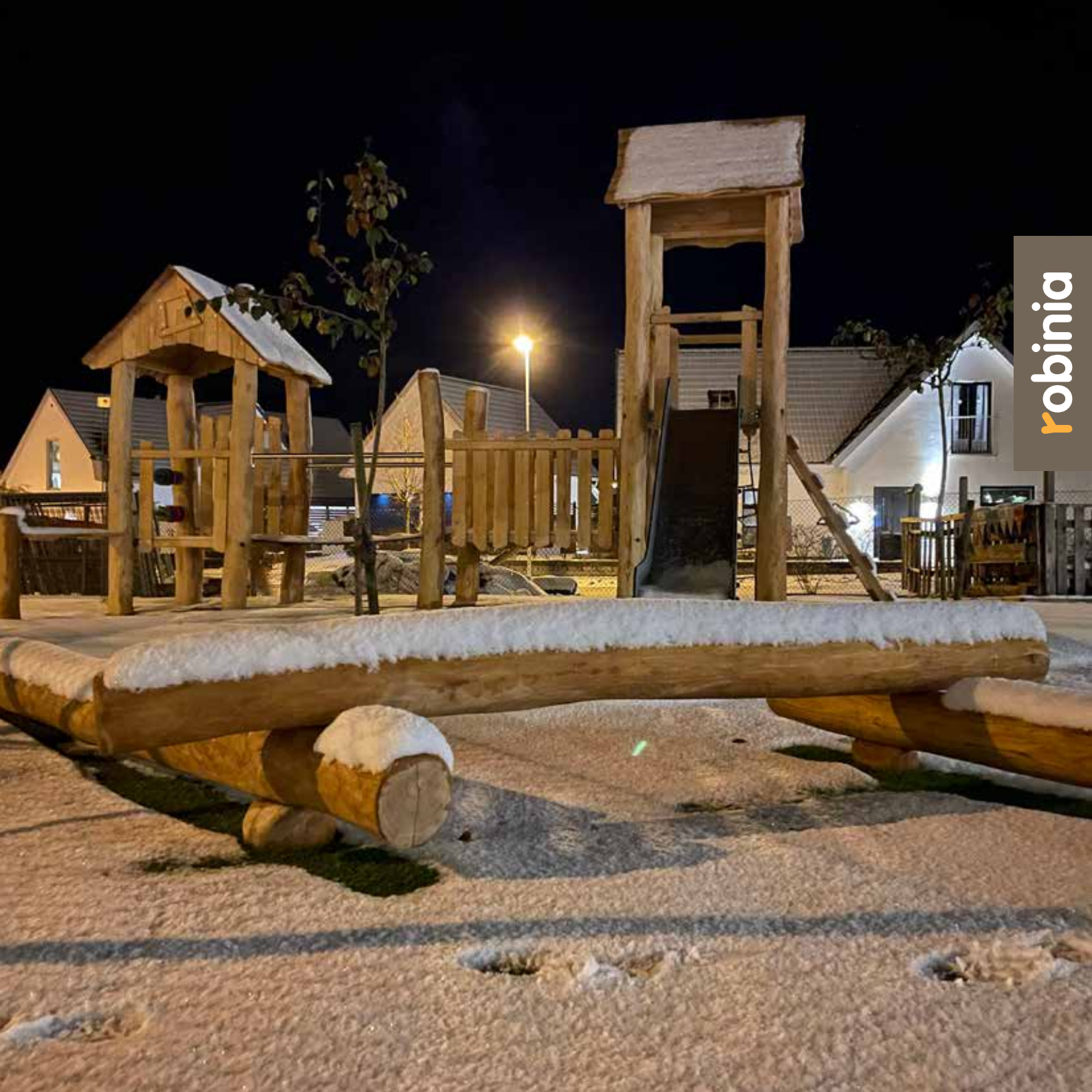

SOLO ARTIKLI

Solo serija je izvor radosti posebno za djecu predškolskog uzrasta, jer tu vlada zabava koja razvija prirodnu kreativnost djeteta, potiče na eksperimente i želju za saradnjom sa drugarima. Bogatstvo elemenata, zajedno sa edukativnim panelima, će sveobuhvatno stimulisati čula i intelektualni razvoj djeteta.

MOBILIJAR ZA DJEČIJI PARK

Ova serija je neophodna dopuna za igralište prilagođeno djeci, a čine je udobne klupe i stolovi, kante za otpatke, informativne table i ograde, dakle svi oni elementi koji će osigurati ugodno opuštanje za djecu, ali i njihovu pratnju, roditelje i staratelje. Svojim dizajnom se zasigurno uklapa u ovu seriju igrališta za djecu kao i svako okruženje.

RB - 0140



2+



0,3x1 m



1 m



9,3 m²



3,3 m



RB - 0080



1-8



0,45x0,35 m



1,1 m



9,6 m²



3,4 m



RB - 0076



1-8



1,19x0,19 m



1,4 m



12,2 m²

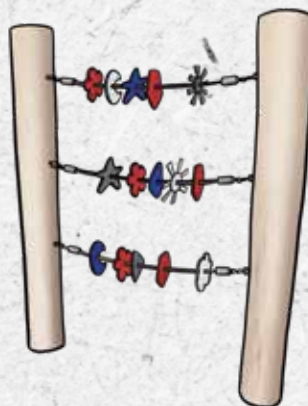

4,19 m



3,19 m

RB - 0071

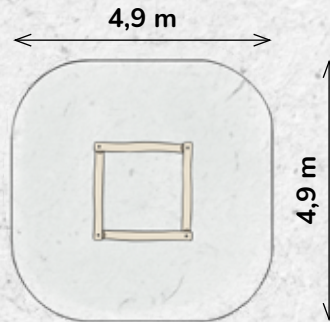
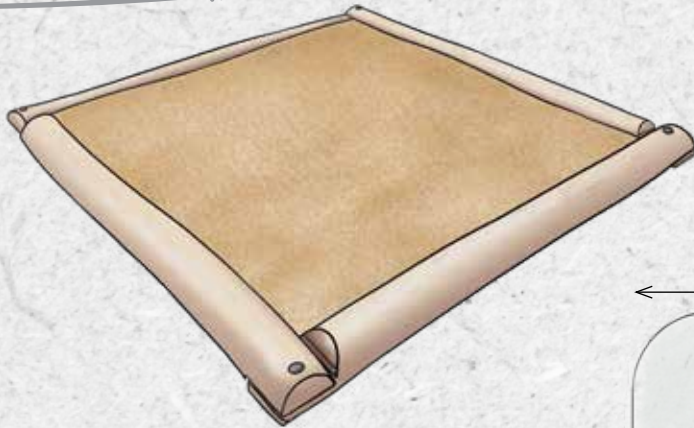

1-12

1,9x1,9 m

0,19 m

23 m²

RB - 0094

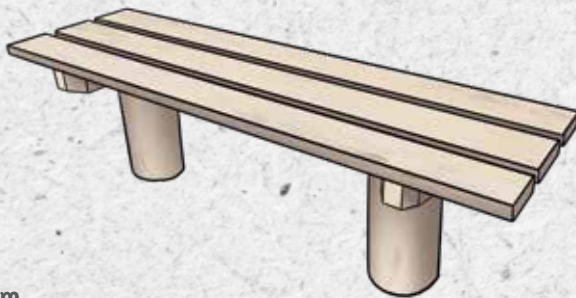

1,5x0,44 m

0,43 m

RB - 0095



0,37x0,3 m

0,76 m

BRIGA ZA VAŠE PROIZVODE OD ROBINIJE

Čak i najbolje drvo robinije na svijetu treba odgovarajuću njegu...

DRVO BAGREMA

Drvo bagrema/robinije je idealno za izradu igrališta prirodnog izgleda i čini se kao da je priroda stvorila drvo robinije samo za tu svrhu! Robinija je kategorizirana kao tvrdo drvo koje može preživjeti u vanjskom okruženju dugi niz godina bez ikakvog hemijskog tretmana. Ima izvrsnu mehaničku čvrstoću i prirodnu otpornost na gljivice i insekte.

DIZAJN PROIZVODA

Svako deblo robinije ima jedinstven oblik, stoga se trudimo da pažljivo odaberemo adekvatna debla i kombinujemo ih sa pločama, krovovima i drugim dodacima kako bismo kreirali igrališta koja se prekrasno stapaju s prirodom. Za optimalnu izdržljivost i najsigurniju igru, naše sprave su sastavljene od posebno dizajnirane čelične konstrukcije.

PUKOTINE I POPRAVAK

Drvo je živi materijal. Promjenjivi vremenski uvjeti (mokro/suho-vruće/hladno) neizbježno znače da će se s vremenom pojaviti pukotine. Iako se neke pukotine ponovno zatvore same od sebe, veće je potrebno popraviti u skladu sa karakteristikama ove vrste drveta.

glovis 



GLOVIS d.o.o. Zenica
Poslovna zona Zenica 1
Zmaja od Bosne bb, 72000 Zenica
Bosna i Hercegovina

TELEFON: +387 32 200 790
EMAIL: info@glovis.ba
WEB: www.glovis.ba

